

All-Round[®] NV

Display & P.O.S. Solutions

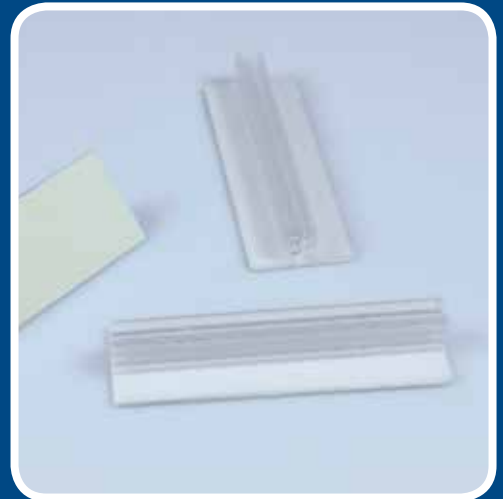

Point of sale

Retail Display

Large range from stock

Our products sell your products

All-Round[®] NV

Display & P.O.S. Solutions

Did we make you curious about our products or are you looking for inspiration for the further finishing of your product?



Then contact us for a showroom visit. All-Round NV is easily accessible thanks to our central location in Aalst close to the E40 between Brussels and Ghent.

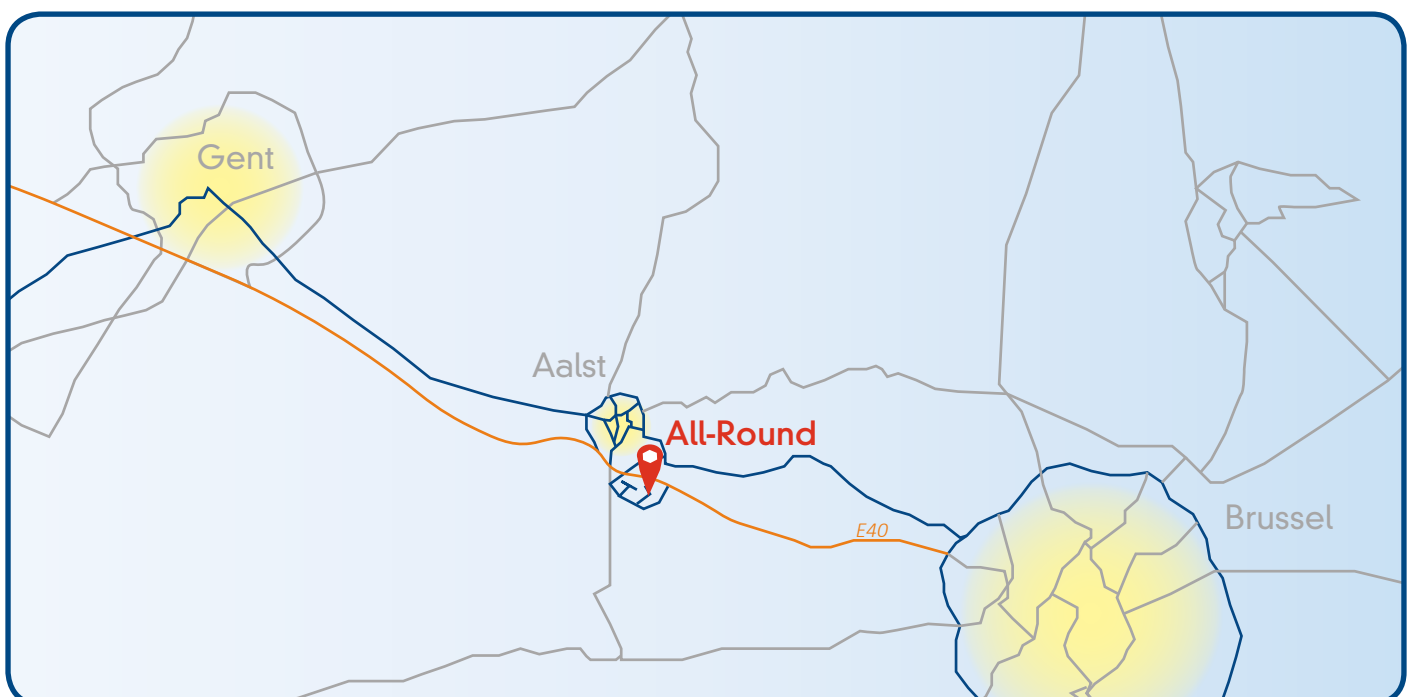



Your products and promotional campaigns are unique and that's why you want to put them in the spotlight.

Are you therefore looking for fixing systems or Point-of-Sale material? Then you are definitely looking for promotional material that attracts your client's attention, that informs them and convinces them to actually make a purchase.

Shelf and display accessories, card holders, mounting systems, brochure holders or mounting material for display constructions: your Point-of-Sale products, need to make your customers stop, amaze them and encourage them to buy. Are you often looking for a fast and professional service, custom-made for your business ?

Don't look any further. All-Round NV is the place to be. A young, dynamic and multilingual team is at your service to give your national and international projects the attention they deserve. This catalogue already gives you an idea of the countless possibilities.

During our collaboration, you will benefit from our extensive expertise and care for all of your projects: discrete or exuberant, small or big, just a finishing touch or an exhaustive project. Based on your wish list and the characteristics of your product, we think out of the box and we'll come up with a tailor-made proposal. Because our products don't only need to convince you, but also your clients in the first place.

Short deadlines? No big deal. We have our own production site, a huge offer and an extensive stock. Besides this, we permanently strive to offer very short delivery times.

As you can see: at All-Round NV you will certainly find the service and products you are looking for to boost your turnover and thereby grow your revenue.

Ready to let your products stand out? Then contact us to fix an appointment with our sales team. Together, we can check which system or product fits your campaign best and how we can personalize it in order to attract and convince your customers.

1. Hanging Systems

• Plastic ceiling hangers

• Magnetic hooks

• Metal ceiling hangers

• Poster profiles



• Mobile hangers

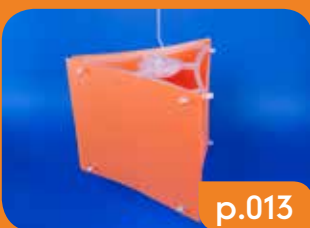

2. Shelf Fitting Accessories

• Wobblers with Easy Peel

• Aluminium wobblers

• Spring wobblers

• Printed wobblers



• Shelf clips

• Banner holders

• Label holders

• Hang Strips



• Hang Strip accessories

• Hang Strips on request



3. Ticket Accessories

• Attachments

• Supergrips

• Pen-holders

• Hanging clips

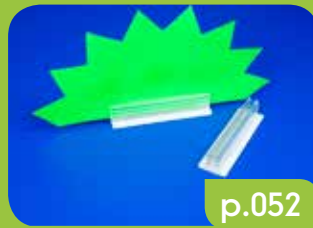

• Fix-Twist

• Wire basket ticket holders

• Supergrip for cardboard / display construction

• Supergrip with hinge



• Supergrip with suction cup

• Ticket holders

• Polystyrene ticket holders

• POS-Clips assembly spare parts



• Suction cups

• Badge holders



4. Leaflet Holders

• Leaflet dispensers

• Brochure stands

• Business card holders

• Card boxes



• Calendar boxes

• Leaflet holders

• Cardboard display stand

• Adhesive pockets



• Non-adhesive pockets



5. Display Accessories

• Pegboard plastic prongs

• Cardboard plastic prongs

• Adhesive plastic prongs

• Universal plastic prongs



• Double-sided plastic prongs

• Pegboard metal prongs

• Stock limiters for prongs

• Label holders for prongs

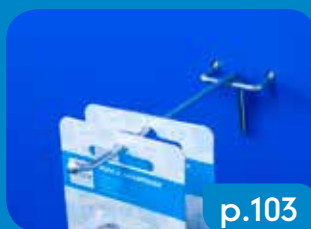

• Anti-theft systems for prongs

• Hang Tabs

• Turn tables

• Cardboard tube accessories

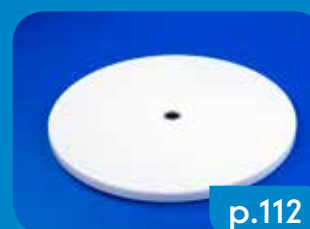

• Display feet accessories



• Display assembly accessories



• LED display accessories



6. Printing Accessories

• Push buttons



• Screws



• Hook & loop fasteners



• Adhesive pads



• Adhesive tapes



• Glue dots



• Magnetic discs



• Magnetic tapes



• File prongs & accessories



• CD accessories



• Ball chains & accessories



• Rings & hooks



7. Frames

• Snap frames



• Frame boards



• Show card stands



• Plastic frames and accessories



● Pavement signs

● Banner displays



p.156



p.160

8. Miscellaneous

● Security systems

● Handles

● Calendar accessories



p.162



p.164



p.165

TABLE OF CONTENTS

HANGING SYSTEMS	1 - 13
Plastic ceiling hangers	2
Magnetic hooks	5
Metal ceiling hangers	7
Poster profiles	10
Mobile hangers.....	13
SHELF FITTING ACCESSORIES	15 - 45
Wobblers with easy peel	16
Aluminium wobblers	19
Spring wobblers.....	22
Printed wobblers	23
Shelf clips.....	24
Banner holders	27
Label holders	32
Hang Strips	37
Hang Strip accessories.....	42
Hang Strips on request	43
TICKET ACCESSORIES	45 - 80
Attachments	46
Supergrips	52
Pen-holders	56
Hanging clips	57
Fix-Twist.....	58
Wire basket ticket holders.....	59
Supergrip for cardboard / display construction.....	61
Supergrip with hinge	63
Supergrip with suction cup.....	64
Ticket holders.....	65
Polystyrene ticket holders	68
POS-Clips assembly spare parts.....	71
Suction cups	72
Badge holders.....	77
LEAFLET HOLDERS	81 - 94
Leaflet dispensers.....	82
Brochure stands.....	84
Business card holders	85
Card boxes	86
Calendar boxes	86
Leaflet holders.....	87
Cardboard display stand.....	92
Adhesive pockets.....	93
Non-adhesive pockets	94
DISPLAY ACCESSORIES	95 - 116
Pegboard plastic prongs	96
Cardboard plastic prongs.....	98
Adhesive plastic prong	99
Universal plastic prongs.....	100
Double-sided plastic prongs	102
Pegboard metal prongs	103
Stock limiters for prongs.....	105
Label holders for prongs.....	106
Anti-theft systems for prongs	107
Hang Tabs	108

Turn tables.....	112
Cardboard tube accessories	112
Display feet accessories.....	113
Display assembly accessories	114
LED display accessories	116

PRINTING ACCESSORIES..... 117 - 146

Push buttons.....	118
Screws	122
Hook & loop fasteners.....	126
Adhesive pads	128
Adhesive tapes	132
Glue dots	135
Magnetic discs.....	135
Magnetic tapes.....	136
File prongs & accessories	138
CD accessories.....	139
Ball chains & accessories.....	141
Rings & hooks.....	142

SNAP FRAMES..... 147 - 161

Snap frames.....	148
Frame boards	152
Show card stand	153
Plastic frames and accessories	155
Pavement signs.....	156
Banner displays	160

MISCELLANEOUS 161 - 166

Security systems	162
Handles.....	164
Calendar accessories	165

PRODUCT CODE

A

ATT3	48
ATT5	47
ATT6	47
ATT7	47
ATT8	47
ATT9	48
ATT10H	48
ATT11H	49
ATT 14	50
ATT15	51
ATT15B	51
ATT16	46
ATT17	46
ATT18	49
ATT22	50

B

BAC1/MT	92
BAC2/MT190	92
BAD1	77
BAD5	77
BAD8	78
BAD12	80
BAD15	94
BAD16	79
BAD20/.../S	94
BAD26	79
BAD33	79
BAD54	80
BAN1	80
BAN1/470	28
BAN1/C	28
BAN1/D	28
BAN4/H	30
BAN4/H	101
BAN4/V	30
BAN4/V	101
BAN8	160
BAN11	27
BAN12	27
BAN13	29
BAN20/80	160
BLI1/4035	111
BLI1/5050	109
BLI2/2740	111
BLI5	110
BLI11	110
BLI154	109
BLI196	109
BLI325	111
BLI340	131
BLI361	109
BLI362	109
BLI364	109
BLI384	109
BLI398	109
BLI1001	110
BLI55429	111
BLI550185	111
BRO2	84

C

CDB	86
CDP	140

CDR	140
CHA	141
CHA3H	141
CHA4	141
CHA9	141
CLI6/10T	59
CLI7	25
CLI7/T	25
CLI7/Z	25
CLI9	57
CLI10	57
CLI13/25	112
CLI17	78
CLI22	78
CLI22/B	25
CLI24	59
COR1	114
COR2	114
COR3	113
COR4	113
COR5	113
COR10	115
COR11	115
COR19	115

D

DAT1	165
DAT2	165
DAT3	165
DAT5	165
DIS4	118
DIS5	122
DIS6	118
DIS8	119
DIS9	119
DIS13	122
DIS13/ACC/LUS	125
DIS13/ACC/OOG	125
DIS15	120
DIS16	120
DIS18	51
DIS19	121
DIS130	124
DOC1	138
DOC2	138
DOC3	138
DOT3	135
DOT4	131
DOT6	131
DRH	93

F

FOA1	128
FOA1/DR	128
FOA1/R20	129
FOA2/R20	130
FOA3	132
FOA4/RT15	129
FOA5	132
FOA6	133
FOA7	133
FOA8	130
FOA10/25	129
FOA11	130
FOA12/12	134
FOA13	134
FOA15	134
FOT4	146

FOT5/40	146
FRA1H/C	155
FRA6	154
FRA/MAG	154

KAD13/A4	84
KAD14	153
KAD16	159
KAD17	159
KAD18	153
KAD19	154
KAD20	159
KAD25	158

H

HAN0	2
HAN1	2
HAN1/RT	58
HAN2	3
HAN3	3
HAN4	3
HAN5	4
HAN6	4
HAN7	4
HAN8	4
HAN10	7
HAN11	7
HAN12	8
HAN14	8
HAN15	7
HAN16	7
HAN17	7
HAN18	8
HAN20	9
HAN22	3
HAN33	25
HAN33/B	25
HAN34	4
HND4	164
HND6	164
HND30	164
HOO3	42
HOO3	142
HOO4	143
HOO5J	143
HOO9/B	144
HOO10	42
HOO10	143
HOO11	144
HOO13	144
HOO14	145
HOO15/35	145
HOO16/60	144
HOO17	42
HOO17	142
HOO18	42
HOO18	142
HOO20N	42
HOO20N	143
HOO21	50
HOO21	145

L

LAB4	32
LAB7	33
LAB8	33
LAB9	34
LAB10	34
LAB11	35
LAB12	35
LAB13	35
LAB15	36
LAB16	115
LAB17	36
LAB20/4065	106
LAB22/300	36
LEA1	90
LEA1/W	90
LEA2	88
LEA3H	82
LEA4/N	82
LEA5/N	82
LEA6/N	82
LEA4X3/N	83
LEA5X4/N	
LEA6/NB	82
LEA8	87
LEA9	87
LEA10	87
LEA10/PET	88
LEA11	88
LEA12	85
LEA13/G	86
LEA13/N	85
LEA13/RVS	85
LEA14	83
LEA14/SLAT	83
LEA17	85
LEA18	87
LEA23	89
LEA24	26
LEA35	90
LEA40/T	86
LED1	116

K

KAD1	148
KAD1L	149
KAD10/	149
KAD1/PU	151
KAD1/W	150
KAD1/WT	150
KAD2H	12
KAD3/M	157
KAD3/P	156
KAD3W	156
KAD5NW	157
KAD9W	158
KAD10	153
KAD10/TAB	153

M

MAG1	5
MAG2	5
MAG4	6
MAG5	136
MAG5/MP	136
MAG7	56
MAG7/5	56
MAG8	78
MAG8/R	78
MAG9	80
MAG10	5
MAG12	135
MAG13	137
MAG20	29
MAG/CLIP	6

MAG/CLIP	137
MEM1	152
MEM2	152
MEM3	152
MEN21	89

P

PEG1	96
PEG2	96
PEG3	96
PEG4	96
PEG5	96
PEG6/50	97
PEG6	97
PEG7	97
PEG8	97
PEG9/60	99
PEG11	100
PEG12	101
PEG12D	102
PEG12P	100
PEG14	103
PEG15	103
PEG16	104
PEG17	106
PEG18	104
PEG20	105
PEG21	105
PEG30	105
PEG32	106
PEG33	106
PEG40/MAG	107
PEG40/R	107
PEG40/Z	107
PEG41/R	107
PEG41/Z	107
PEN1	56
PEN3	57
PLO/...	89
POC1/RH	93
POC5	139
POC6	139
POC8	139
POCES	94
POL2	112
POL3	112
POS1	10
POS3	10
POS6/T	12
POS8/18	11
POS10	11
PRO1/./3	98
PRO1/50/3	98
PRO1/100/3	98
PRO1/150/3	98
PRO1/200/3	98
PRO2	98
PRO3/./3	99
PRO4	99
PUL2H	163
PUL2H/L	163

R

RAZ2	31
RAZ4	31

S

SAF1	162
SAF2	162
SAF3	162
SAF3/W	162
SEL1	38
SEL1/S	37
SEL1/L	37
SEL2	38
SEL3	39
SEL4	39
SEL5	40
SEL6	40
SEL9	39
SEL11	40
SEL12	41
SHE5/S	24
SHE7	24
SUC1	72
SUC2-II	73
SUC2/ZH	73
SUC3/P	73
SUC4H	73
SUC5	74
SUC6	74
SUC7	74
SUC8	75
SUC9	76
SUC10	74
SUC13	72
SUC14	75
SUC16	76
SUC50	75
SUP1/15	54
SUP1	54
SUP2	54
SUP1/3	54
SUP1/50	54
SUP4	54
SUP5	54
SUP7	54
SUP7M/75	56
SUP7M	56
SUP5/5	54
SUP5/5/35	54
SUP8	54
SUP9	54
SUP21	26
SUP24/75	54
SUP25	54
SUP26	54
SUP28	55
SUP29	55
SUP30	55
SUP39	55
SUP40	55
SUP47	59
SUP50	60
SUP52	60
SUP54	60
SUP55	61
SUP56	61
SUP57	62
SUP58	62
SUP59	62
SUP60	62
SUP61/01	63
SUP62	64
SUP63	64
SUP66	63

SUP66/25	63
SUP66M	63
SUP69	55
SUP73	60
SUP77	64
SUP_PP1	54

T

TAB3	112
TIC 6	66
TIC7	65
TIC8/B	65
TIC9	65
TIC10	70
TIC50/01	71
TIC50/05	71
TIC50/02	71
TIC50/06	71
TIC50/03	71
TIC50/04	71
TIC50/07	71
TIC11/V	66
TIC12	66
TIC14	67
TIC23	67
TIC25/100	68
TIC27	68
TIC29	68
TIC32	69
TIC36	69
TIC38	69
TIC39	70
TIC44	70
TRI1	13
TRI2	13
TRI4	13

V

VEL10	126
VEL11	127
VEL12	127
VEL20	127

W

WIN2	59
WOB1	17
WOB2	20
WOB2/2T	18
WOB3/2	20
WOB4	22
WOB4/GM	22
WOB5	22
WOB5/B	22
WOB11	17
WOB12	18
WOB13	18
WOB20	21
WOB21	21
WOB24	21

1. Hanging Systems

Make your promotional or information campaign stand out and therefore optimize all available space?

Then our hanging systems are the solution you are looking for. Ceiling mountings and posters immediately drag the attention and clearly let your clients know about pricing and promotions of your products.

Hanging systems can be fixed to all kinds of wall and ceiling surfaces: depending on the surface, you can opt for hooks, clamps or clips. Even handier and more refined are magnetic or adhesive systems. The guiding principle of all these options? Sustainability and user friendliness.

No idea of what is your best option? Then get in touch for a non-binding tailor-made proposal.

1.1 Plastic ceiling hangers

1.2 Magnetic hooks

1.3 Metal ceiling hangers

1.4 Poster profiles

1.5 Mobile hangers

1.1 Plastic ceiling hangers

Our plastic ceiling hangers are quick and easy to use. They are available in different sizes and shapes and can be attached by sticking them on to the ceiling or clipping them on the ceiling grid.

1

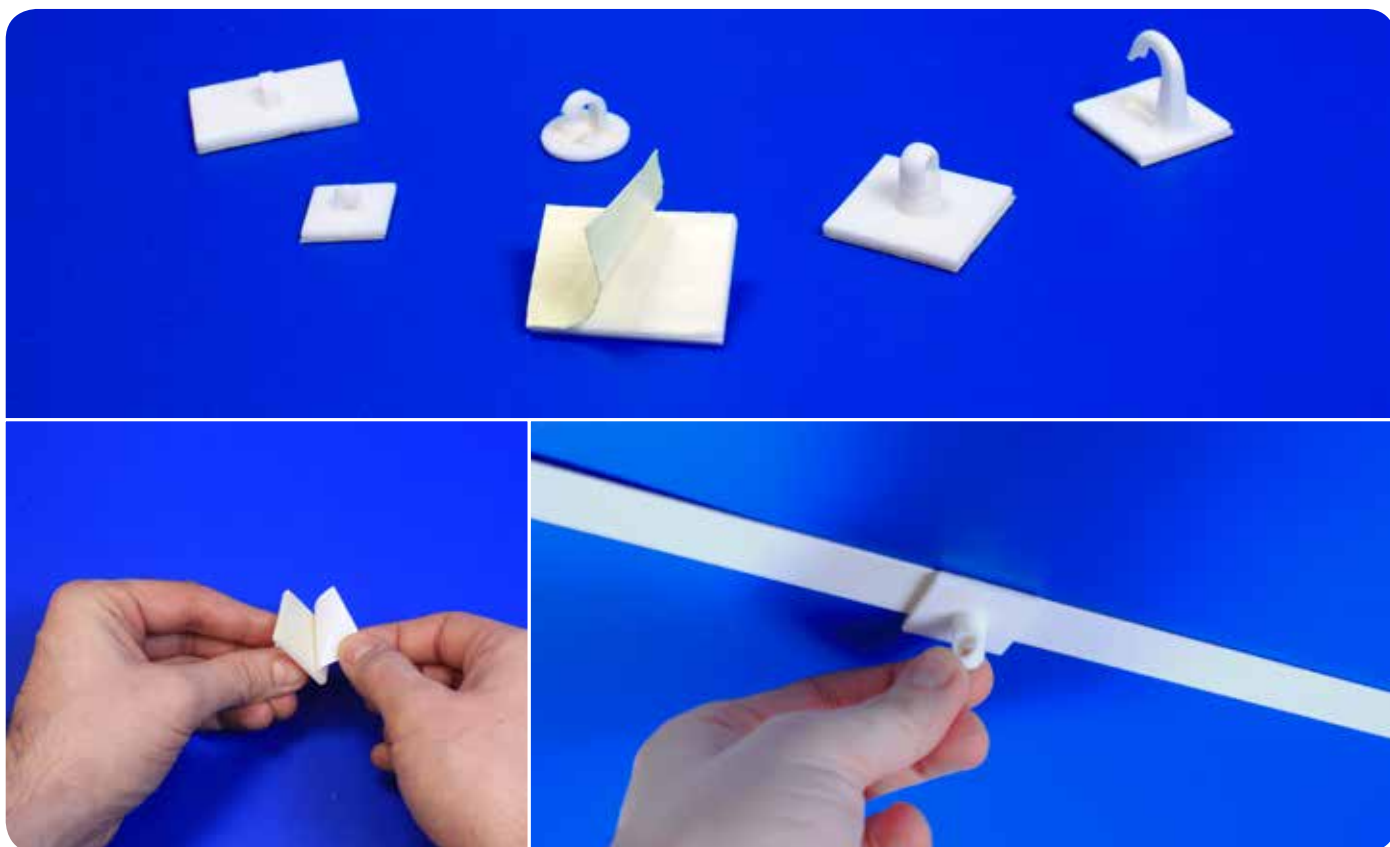

HANO - HAN1

Square white button with adhesive foam.

	L	W	ADHESIVE	<input checked="" type="checkbox"/>	
HANO	18mm	18mm	Permanent	●	
HAN1	20mm	20mm	Permanent	●	

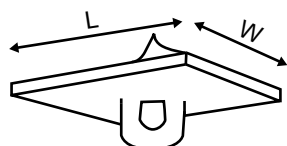

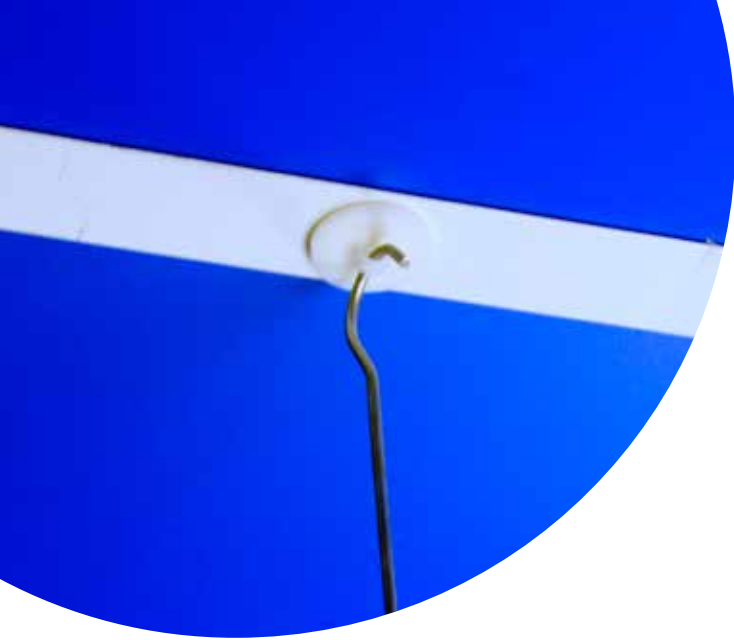

HAN22

Round white button with adhesive foam.

∅	ADHESIVE	<input checked="" type="checkbox"/>	
22mm	Removable	•	

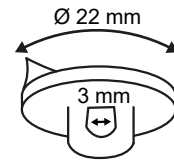

1

HAN3

Rectangular white button with adhesive foam.

L	W	ADHESIVE	<input checked="" type="checkbox"/>	
37mm	26mm	Permanent	•	

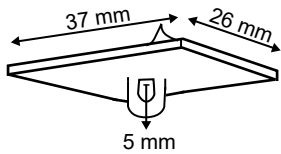

HAN4

Square white button with adhesive foam and a rotating suspension eye.

L	W	ADHESIVE	<input checked="" type="checkbox"/>	
30mm	30mm	Permanent	•	

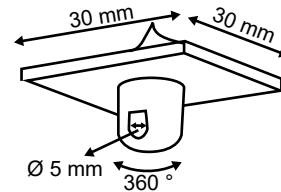

HAN2

Square white button with adhesive foam and a hook.

L	W	ADHESIVE	<input checked="" type="checkbox"/>	
25mm	25mm	Permanent	•	

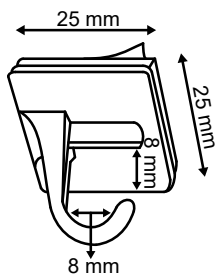

HAN34

Round white button with adhesive foam and a hook.
Can also be used as a pen holder.

	∅	ADHESIVE	<input checked="" type="checkbox"/>	
HAN34	20mm	Permanent	<input type="checkbox"/>	<input type="checkbox"/>

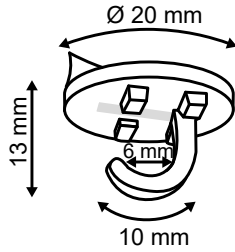

HAN6 - HAN7 - HAN8

Ceiling clip for hanging hooks and wires from the ceiling (T-rails).

	L	W	FIXATION	COLOR	<input checked="" type="checkbox"/>	
HAN6	19mm	30mm	Clip	White	<input type="checkbox"/>	<input type="checkbox"/>
HAN7	22mm	20mm	Clip	Transparent	<input type="checkbox"/>	<input type="checkbox"/>
HAN8	20mm	20mm	Clip	Transparent	<input checked="" type="checkbox"/>	<input type="checkbox"/>



HAN6

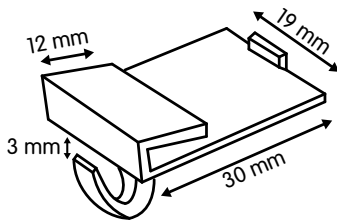

HAN7

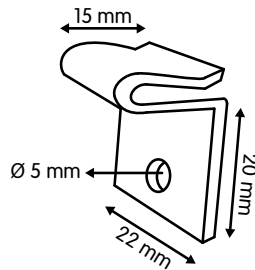

HAN8

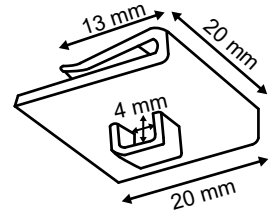

HAN5

Round white self-adhesive plastic plate with stud.

	∅	ADHESIVE	<input checked="" type="checkbox"/>	
HAN5	20mm	Permanent	<input type="checkbox"/>	<input type="checkbox"/>

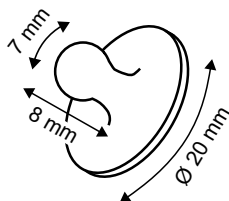

1.2 Magnetic hooks

Our magnetic hooks are very simple and easy to use. Perfect for metal ceilings or places where no adhesive can be used. They are available in different sizes, strengths and shapes.

1



MAG1 - MAG2 - MAG10

Magnetic hooks

	L	W	Ø	SHAPE	<input checked="" type="checkbox"/>	
MAG1	13mm	14mm	/	Square	•	
MAG2	13mm	37mm	/	Square	•	
MAG10	/	/	16mm	Round	•	

MAG1

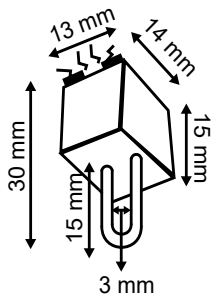

MAG2

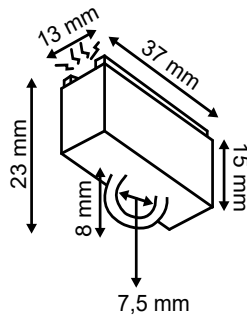

MAG10

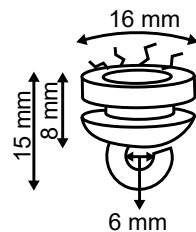

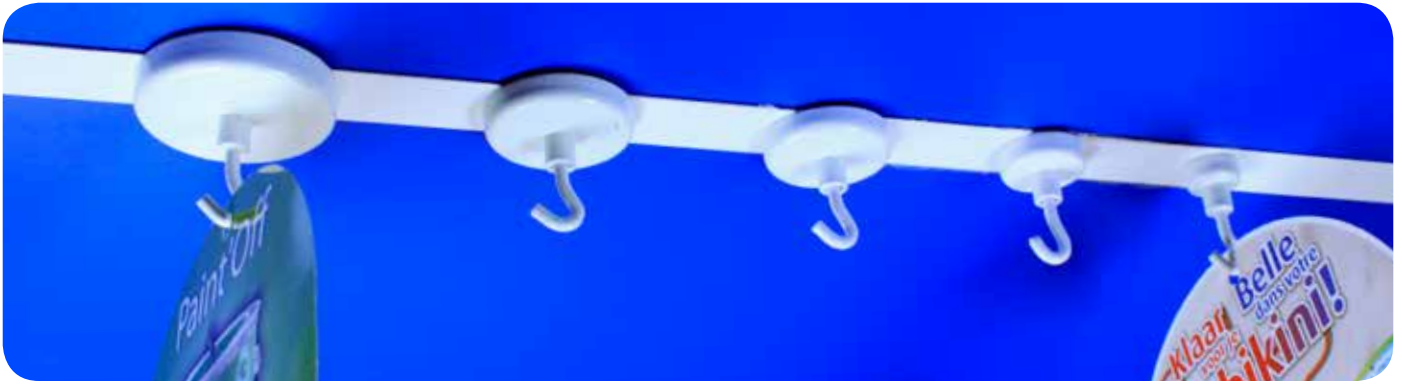

MAG4

Magnetic round white hooks.

	Ø	☑	🛒
MAG4/25	25mm	●	
MAG4/36	36mm	●	
MAG4/40	40mm		●
MAG4/50	50mm	●	
MAG4/63	63mm		●



MAG/CLIP

Magnetic graphic clip holder with adhesive back, to hold promotional media or signage in place where magnets cannot be used.

→ Magnetic back and design supplied on request.

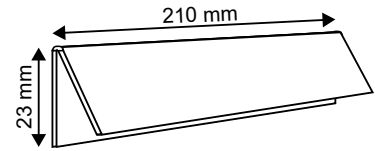

	L	H	☑	🛒
MAG/CLIP	210mm	23mm	●	

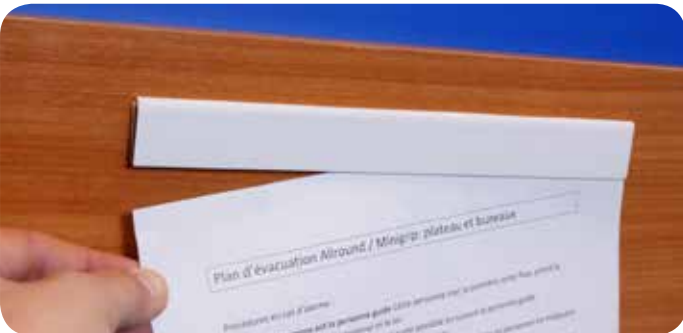

L → length | W → width | H → height | Ø → diameter | → capacity | → stock | → on request

1.3 Metal ceiling hangers

Our metal ceiling hangers are quick and easy to use. They are available in different sizes and shapes and can be attached by clipping them on the ceiling grid.

HAN10 - HAN11

Metal hook to suspend on the ceiling grid.

	W	H	FIXATION	<input checked="" type="checkbox"/>	
HAN10	30mm	67mm	Clip	<input type="checkbox"/>	
HAN11	8mm	30mm	Clip	<input type="checkbox"/>	

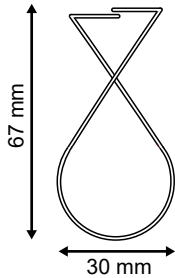

HAN10

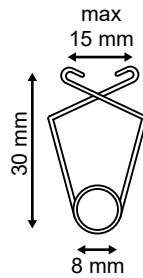

HAN11





HAN15 - HAN16 - HAN17

Extensible wire hook. Can be pulled to the desired length.

	L min	L max	<input checked="" type="checkbox"/>	
HAN15	320mm	2500mm	<input type="checkbox"/>	
HAN16	210mm	1400mm	<input type="checkbox"/>	
HAN17	160mm	1300mm	<input type="checkbox"/>	



L → length | W → width | H → height | Ø → diameter |  → capacity | → stock |  → on request

HAN12 - HAN14

Wire hanger with a needle and metal hook.

1

	H	WIDTH HOOK	LENGTH WIRE	<input checked="" type="checkbox"/>	
HAN12	120mm	18mm	1200mm	•	
HAN14	120mm	42mm	1500mm	•	

HAN12

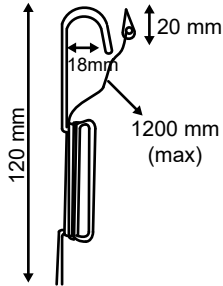

HAN14

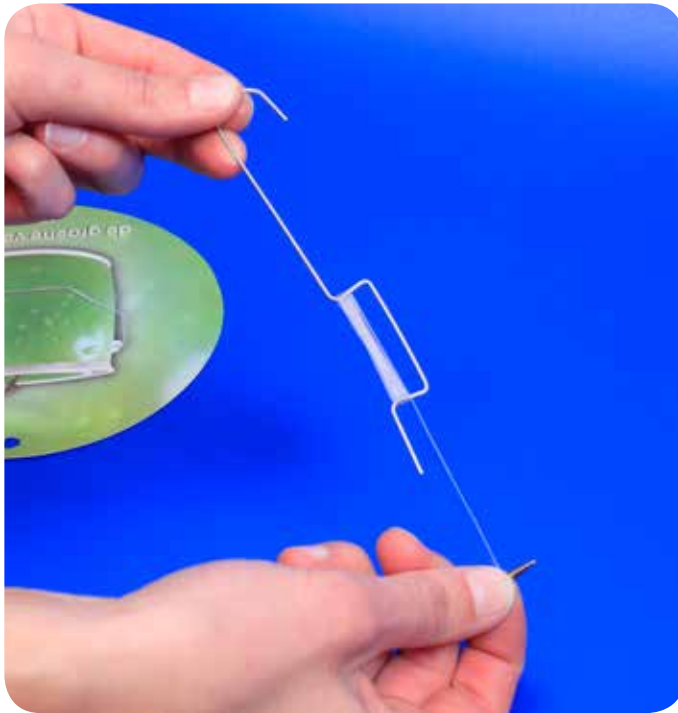
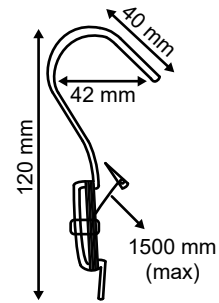

HAN18

Nylon wire on reels.

	THICKNESS	L.REEL	<input checked="" type="checkbox"/>	
HAN18/0.25	0.25mm	200m	•	
HAN18/0.30	0.30mm	200m	•	
HAN18/0.35	0.35mm	200m		•
HAN18/0.40	0.40mm	100m		•
HAN18/0.50	0.50mm	100m		•
HAN18/0.60	0.60mm	100m		•
HAN18/0.70	0.70mm	100m		•



L → length | W → width | H → height | Ø → diameter |  → capacity | → stock |  → on request

HAN20

Metal double C-hook.

	L	THICKNESS	Ø HEAD	☑	🛒
HAN20/60	60mm	2mm	16mm	●	
HAN20/100	100mm	2mm	19mm	●	
HAN20/150	150mm	2mm	20mm	●	
HAN20/200	200mm	2mm	14mm	●	
HAN20/250	250mm	2mm	14mm	●	
HAN20/300	300mm	2mm	15mm	●	
HAN20/400	400mm	2mm	16mm	●	
HAN20/500	500mm	2mm	16mm	●	
HAN20/600	600mm	2mm	16mm	●	
HAN20/750	750mm	2mm	20mm	●	
HAN20/800	800mm	2mm	20mm	●	
HAN20/1000	1000mm	2mm	20mm	●	
HAN20/1500	1500mm	2mm	20mm	●	
HAN20/2000	2000mm	2mm	20mm	●	



L → length | W → width | H → height | Ø → diameter | → capacity | → stock | → on request

1.4 Poster Profiles

We offer a variety of PVC profiles for hanging posters. Easy installation allow anyone to hang a poster made of cardboard, vinyl, textile, etc.



POS1

PVC poster profile available in different lengths and colors.
 Quick lead time if size is above 140mm for a quantity under 1000 units.
 → Custom lengths on request.
 → Maximum capacity: 3mm

	L	COLOR	☑	🛒
POS1/100	1000mm	White	●	
POS1/120	1200mm	White	●	
POS1/30	300mm	White		●
POS1/40	400mm	White	●	
POS1/50	500mm	White	●	
POS1/60	600mm	White	●	
POS1/70	700mm	White	●	
POS1/80	800mm	White	●	
POS1/90	900mm	White	●	
POS1/T/100	1000mm	Transparent	●	
POS1/T/120	1200mm	Transparent	●	
POS1/T/125	1250mm	Transparent		●
POS1/T/50	500mm	Transparent	●	
POS1/T/60	600mm	Transparent	●	
POS1/T/70	700mm	Transparent	●	
POS1/T/85	850mm	Transparent	●	
POS1/T/90	900mm	Transparent	●	
POS1/Z/100	1000mm	Black	●	
POS1/Z/120	1200mm	Black	●	
POS1/Z/30	300mm	Black		●
POS1/Z/40	400mm	Black	●	
POS1/Z/50	500mm	Black	●	
POS1/Z/60	600mm	Black	●	
POS1/Z/70	700mm	Black	●	
POS1/Z/80	800mm	Black	●	
POS1/Z/85	850mm	Black	●	
POS1/Z/90	900mm	Black	●	



POS3

Suspension hook to be used in combination with poster profile POS1.

L	W	H	☑	🛒
20mm	7mm	25mm	●	

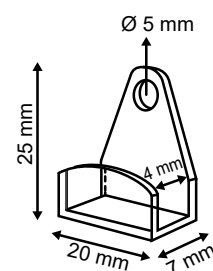

L → length | W → width | H → height | Ø → diameter | → capacity | → stock | → on request

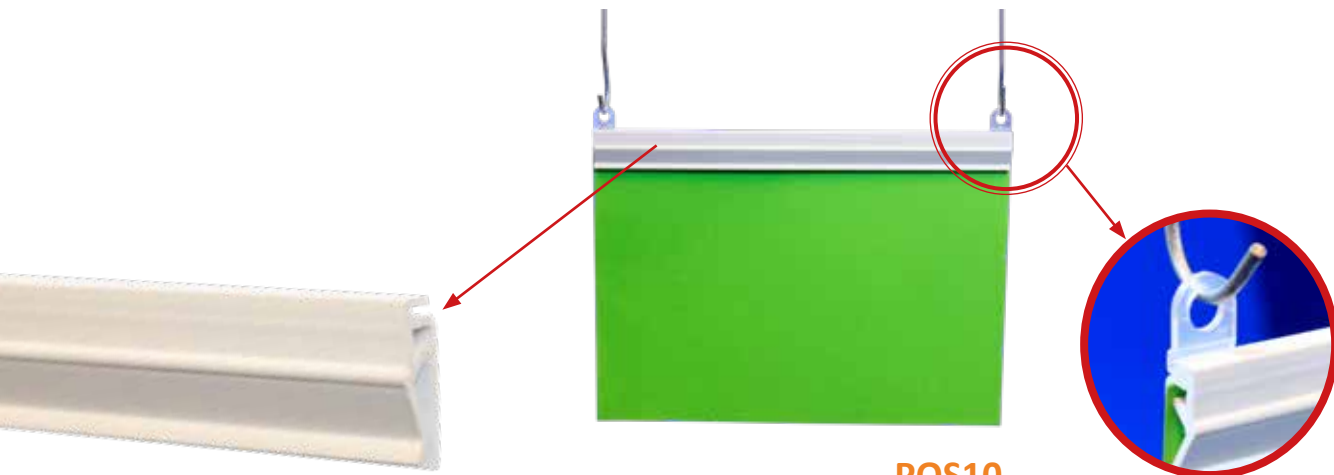

POS10

Suspension hook to be used in combination with the click profile POS8/18.

L	B	H	∅	<input checked="" type="checkbox"/>	
10mm	4,5mm	14mm	6mm	•	

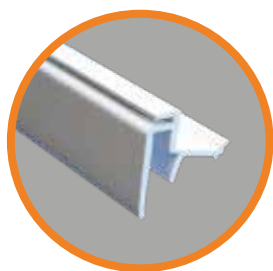
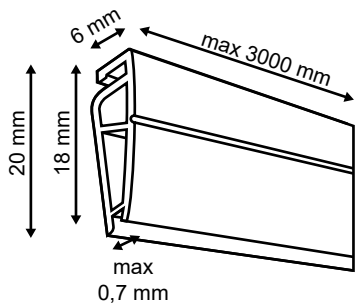

POS8/18

PVC poster profile with clip mechanism. Available in different lengths and colors. Quick lead time if size is above 140mm for a quantity under 1000 units.

- Custom lengths on request.
- Maximum capacity: 0,7mm

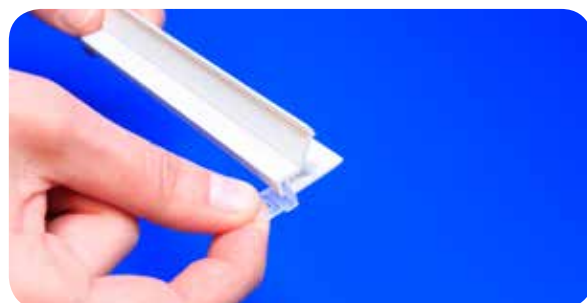
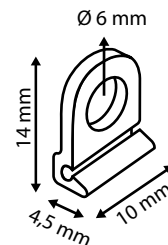

	L	COLOR	<input checked="" type="checkbox"/>	
POS8/18/100	1000mm	White	•	
POS8/18/120	1200mm	White	•	
POS8/18/50	500mm	White	•	
POS8/18/60	600mm	White	•	
POS8/18/80	800mm	White	•	
POS8/18/90	900mm	White	•	
POS8/18/T/100	1000mm	Transparent	•	
POS8/18/T/120	1200mm	Transparent	•	
POS8/18/T/140	1400mm	Transparent	•	
POS8/18/T/40	400mm	Transparent	•	
POS8/18/T/50	500mm	Transparent	•	•
POS8/18/T/60	600mm	Transparent	•	
POS8/18/T/70	700mm	Transparent	•	
POS8/18/T/80	800mm	Transparent	•	
POS8/18/Z/100	1000mm	Black	•	
POS8/18/Z/120	1200mm	Black	•	
POS8/18/Z/50	500mm	Black	•	
POS8/18/Z/60	600mm	Black	•	

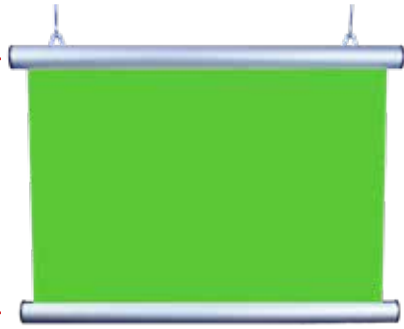
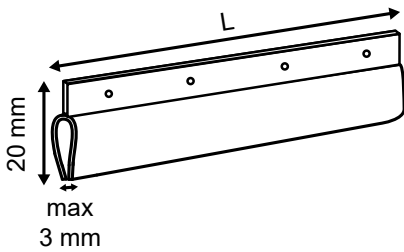

POS6/T

Clear PVC poster profile with perforated suspension eyes.

	L	<input checked="" type="checkbox"/>	
POS6/T/40	400mm	●	
POS6/T/60	600mm	●	
POS6/T/80	800mm	●	
POS6/T/120	1200mm	●	

KAD2H

Aluminum profiles for hanging posters. One set contains 2 aluminum snap profiles, 2 suspension eyes and 2 end caps. Profile height: 26mm.

→ Custom lengths on request.

	L	<input checked="" type="checkbox"/>	
KAD2H/100	1000mm	●	
KAD2H/120	1200mm	●	
KAD2H/125	1250mm	●	
KAD2H/150	1500mm	●	
KAD2H/200	2000mm	●	
KAD2H/42	420mm	●	
KAD2H/50	500mm	●	
KAD2H/60	600mm	●	
KAD2H/70	700mm	●	
KAD2H/85	850mm	●	
KAD2H/90	900mm	●	



1.5 Mobile hangers

Our Triarama and Quadrama spins and floats with the air flow. They give a 180° view to the promotial material. To suspend form the ceiling or on a stand.

1

TRI1 - TRI2

Clear polypropylene 3-sider.

1 set contains top and bottom triangle.

	L. ARMS	SIZE PAGES	<input checked="" type="checkbox"/>	
TRI1	160mm	A4 Landscape	<input type="checkbox"/>	
TRI1	160mm	A3 Portrait	<input type="checkbox"/>	
TRI2	317mm	A3 Landscape	<input type="checkbox"/>	<input type="checkbox"/>
TRI2	317mm	A2 Portrait	<input type="checkbox"/>	<input type="checkbox"/>

TRI1

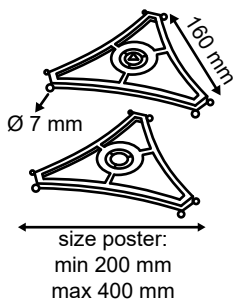

TRI2

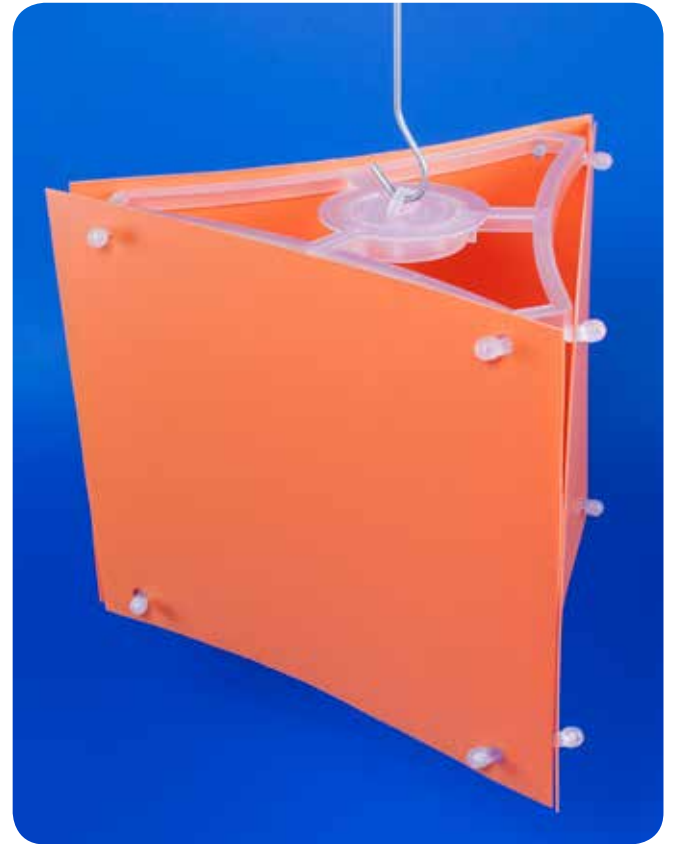
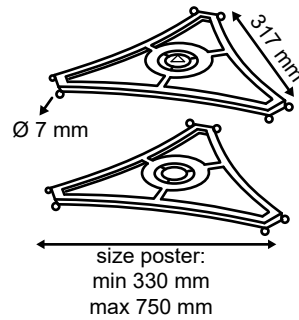

TRI4

Clear polypropylene 4-sider.

1 set contains top and bottom square.

	L.ARMS	SIZE PAGES	<input checked="" type="checkbox"/>	
TRI4	160mm	A4 Landscape	<input type="checkbox"/>	
TRI4	160mm	A3 Portrait	<input type="checkbox"/>	

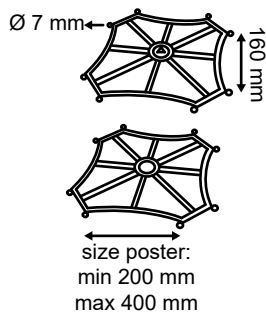

All-Round[®] NV

Display & P.O.S. Solutions



2. Shelf Fitting Accessories

The best possible way to guide your clients through the shelves is by using shelf fitting accessories. They drag your client's eye to specific products and are very easy to use: with these systems, you can modify prices and promotions in the blink of an eye.

Shelf fitting accessories come in three options:

- Label holders for price information
- Wobblers, shelf talkers and banner holders:
The perfect solutions to make your products stand out from the mass on the shelf
- Hang Strips to tempt your clients to go for impulse buys

We offer a personalized design for each product & each promotion. The possibilities within this range really are endless.

2.1 Wobblers with Easy Peel

2.2 Aluminium wobblers

2.3 Spring wobblers

2.4 Printed wobblers

2.5 Shelf clips

2.6 Banner holders

2.7 Label holders

2.8 Hang Strips

2.9 Hang Strip accessoires

2.10 Hang Strips on request

2.1 Wobblers with Easy Peel

Wobblers are made of strong clear recyclable PET which stick to most clean surfaces whilst being easy to remove without marking.



Experienced manufacturer



With Easy Peel



100 % recyclable

WOB1

Clear PET straight wobbler on sheets, with easy peel adhesive on both ends at the same side. These are designed to provide a user-friendly application without the traditional issue of removing release paper. This has the huge advantage to prepare promotion or printed media onto the wobbler arm, ready for stores to remove the Easy Peel backing paper to place in position.

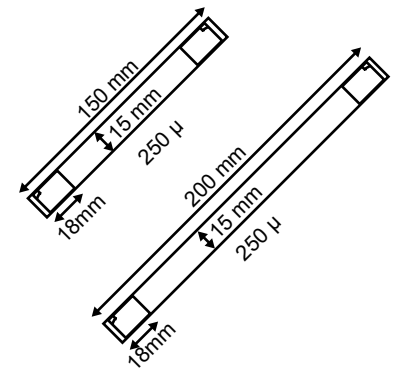

	L	W	PADS	THICKNESS	ADHESIVE	PACKAGING	<input checked="" type="checkbox"/>	
WOB1/15M	150mm	15mm	18mm	PET 250μ	Permanent	Sheets of 10 Packs of 100	•	
WOB1/20M	200mm	15mm	18mm	PET 250 μ	Permanent	Sheets of 10 Packs of 100	•	

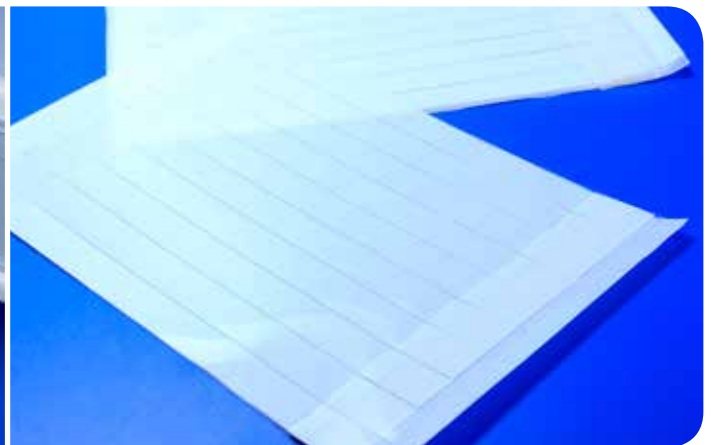
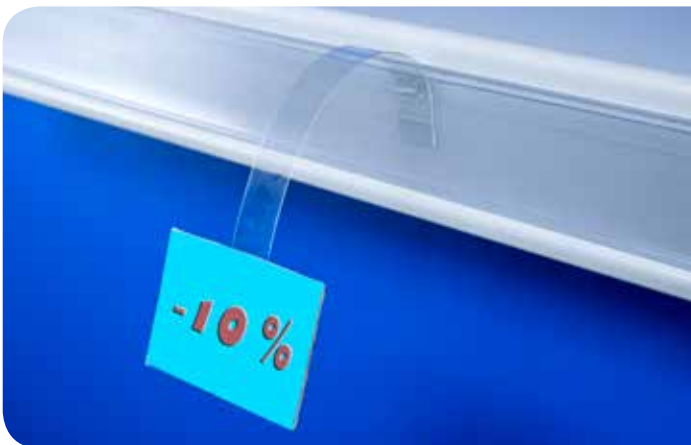

WOB11

Clear PET wobbler with easy peel foam adhesive on one end. The other end of the wobbler is provided with an insert system to place your message, which is hanging perpendicular to the shelf.

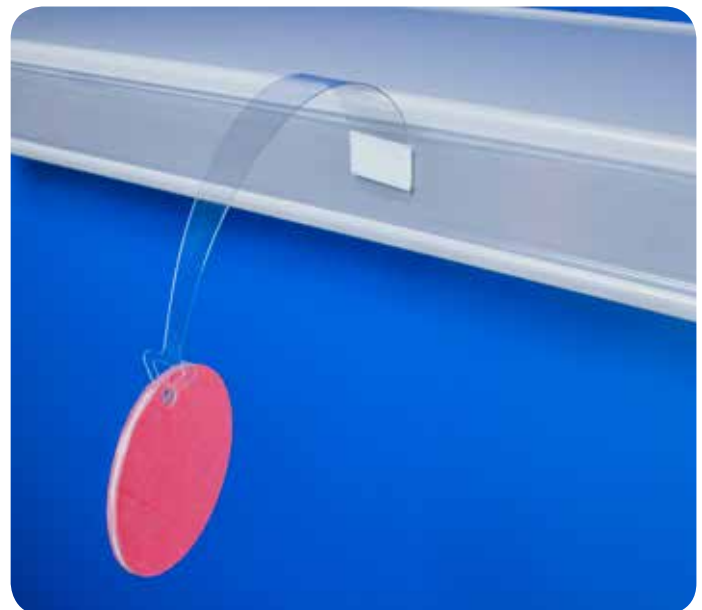
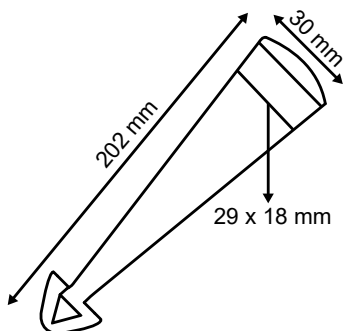

	L	W	PADS	THICKNESS	ADHESIVE	PACKAGING	<input checked="" type="checkbox"/>	
WOB11	202mm	30mm	29 x 18mm	PET 380 μ	Permanent	Loose (packs of 100)	•	

WOB12

Clear PET wobbler with easy peel foam adhesive on both ends at the same side.

→ Also available with removable adhesive on one end.

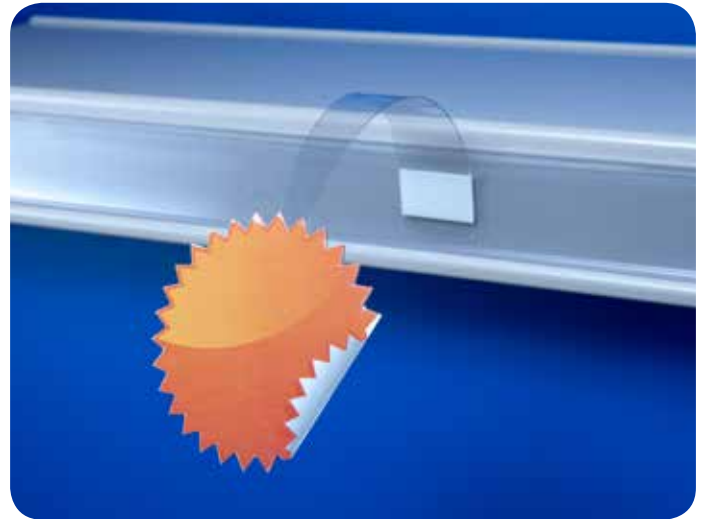
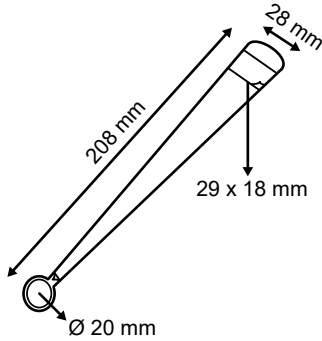

	L	W	THICKNESS	ADHESIVE	PACKAGING	<input checked="" type="checkbox"/>	
WOB12	208mm	28mm	PET 380μ	Permanent/ Removable	Loose (packs of 100)	•	

WOB13

Clear PET wobbler with easy peel foam adhesive on both ends at the same side.

→ Recommended for lightweight cards.

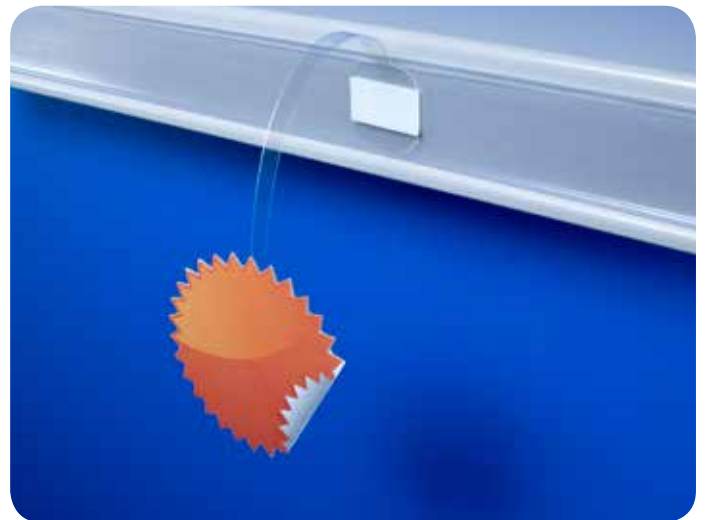
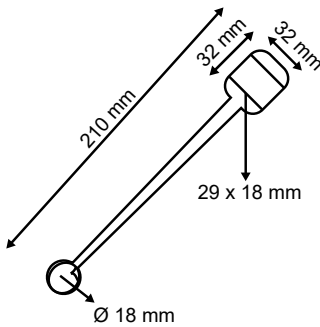

	L	W	THICKNESS	ADHESIVE	PACKAGING	<input checked="" type="checkbox"/>	
WOB13	210mm	32mm	PET 380μ	Permanent	Loose (packs of 100)	•	

WOB2/2T

Clear PET swinging wobbler with clear easy peel adhesive on both ends at the same side.

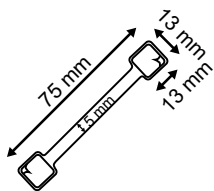

	L	W	THICKNESS	ADHESIVE	PACKAGING	<input checked="" type="checkbox"/>	
WOB2/2T	75mm	13mm	PET 250μ	Permanent	Sheets of 10 Packs of 100	•	

L → length | W → width | H → height | Ø → diameter | → capacity | → stock | → on request

2.2 Aluminum wobblers

The big advantage of aluminium wobblers is that they can be shaped as needed. We do have a large variety available: different sizes and adhesives will fit for any need.



2



Strong & reliable



For fast presentation



Can be shaped into different positions

WOB2

Aluminum adhesive and twistable wobblers.

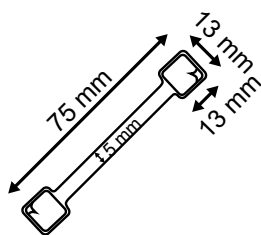

	L	SIZE PADS	STICKY PADS	ADHESIVE	<input checked="" type="checkbox"/>	
WOB2/2M	75mm	13x13mm	2 on both ends	3M Tape permanent	•	
WOB2/2MZ	75mm	13x13mm	2 on both ends	Permanent	•	
WOB2/2MR	75mm	13x13mm	2 on both ends	White side : removable Other side : permanent	•	
WOB2/3M/R	75mm	13x13mm	2 on one end 1 on the other end	White side : removable Other side : permanent	•	
WOB2/2	75mm	20x12mm	2 on both ends	3M Tape permanent	•	

WOB3/2

Large aluminum adhesive twistable wobbler with two pads on both ends at the same side.

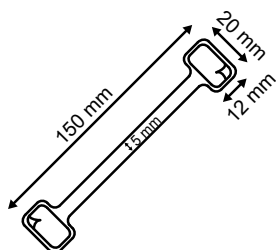

	L	SIZE PADS	STICKY PADS	ADHESIVE	<input checked="" type="checkbox"/>	
WOB3/2	150mm	20x12mm	2 on both ends	Permanent	•	

WOB20

White metal adhesive and twistable wobbler with 3 round pads.

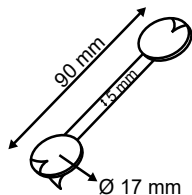

2

	L	Ø PADS	STICKY PADS	ADHESIVE	<input checked="" type="checkbox"/>	
WOB20	90mm	17mm	2 on one end 1 on the other end	Permanent	•	

WOB21

Aluminum adhesive and twistable wobblers with 2 large pads.

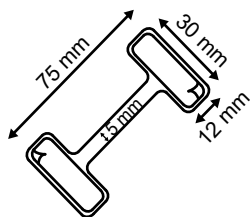

	L	SIZE PADS	STICKY PADS	ADHESIVE	<input checked="" type="checkbox"/>	
WOB21	75mm	30x12mm	2 on both ends	Permanent	•	
WOB21/3/R	75mm	30x12mm	2 on both ends	White side : removable Other side : permanent	•	

WOB24

Extra-large aluminum twistable wobbler with 2 adhesive pads.

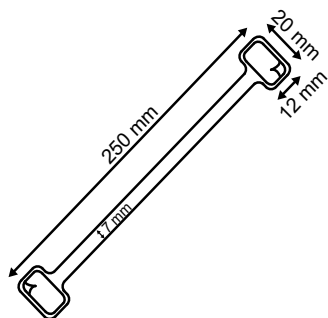

	L	SIZE PADS	STICKY PADS	ADHESION	<input checked="" type="checkbox"/>	
WOB24	250mm	20x12mm	2 on both ends	Permanent	•	

L → length | W → width | H → height | Ø → diameter | → capacity | → stock | → on request

2.3 Spring wobblers

Spring Wobblers provide eye-catching movement to small signage. The wobblers resist being displaced by knocks or joshing.

WOB4

Spring wobbler with adhesive pads.

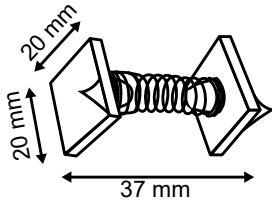

WOB4/GM

Spring wobbler with one adhesive pad on one side and a ticket holder on the other side.

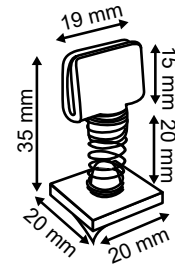

	L	STICKY PADS	ADHESIVE	<input checked="" type="checkbox"/>	
WOB4	37mm	2 on both ends	Permanent	•	
WOB4/GM	35mm	One	Permanent	•	

WOB5 - WOB5/B

White polypropylene spacer with adhesive foam pads on each end. Creates a space between the shelf and the message.

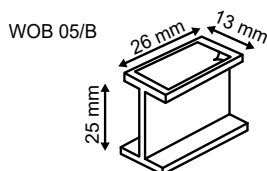
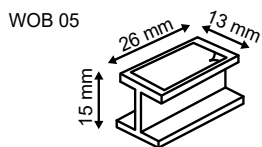

	H	STICKY PADS	ADHESIVE	<input checked="" type="checkbox"/>	
WOB5	15mm	2 on both ends	Permanent	•	
WOB5/B	25mm	2 on both ends	Permanent	•	

L → length | W → width | H → height | Ø → diameter | → capacity | → stock | → on request

2.4 Printed wobblers

Printed wobblers are designed to grab the attention of shoppers as they scan the shelves for the products they wish to purchase.

Displaying a short but powerful message on a wobbler triggers a customer's thought to the message or product and stimulates into buying or following the message.

OUR HIGHLY DURABLE WOBLERS DO HAVE FOLLOWING FEATURES:

Any shape, any design, any print, any size is possible



Printed on 300gsm board or PVC

Can be gloss laminated at extra costs



With & without adhesive on the T-Bar



2.5 Shelf clips

Shelf clips are an easy way to grab customers' attention while walking around the retail shelves. It focuses their attention on the items in that area. Shelf clips can be removed easily at the end of a promotion. Shelf clips can also be used in combination with a coupon holder for a special discount action.



SHE5/S

Flexible shelf clip with a perforation hole at the bottom. Fits onto scanner profiles from 30 to 39mm.

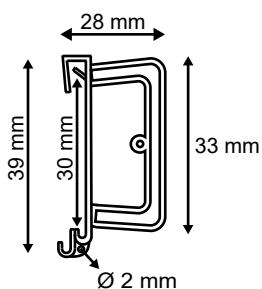

H	W	COLOR	<input checked="" type="checkbox"/>	
39/30mm	28mm	Clear	●	

SHE7

Flexible bus stop shelf clip. Fits onto scanner profiles from 30 to 39mm.

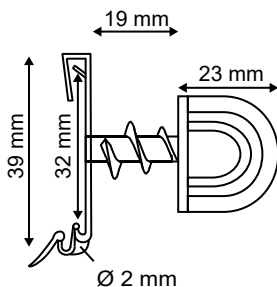

H	W	COLOR	<input checked="" type="checkbox"/>	
39/32mm	42mm	White	●	

L → length | W → width | H → height | Ø → diameter | → capacity | → stock | → on request

CLI7 - CLI7/T - CLI7/Z

Merchandising clamp in white, transparent or black.

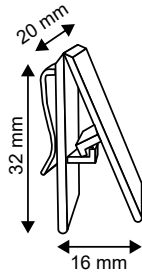

	H	W	COLOR	<input checked="" type="checkbox"/>	
CLI7	32mm	20mm	White	•	
CLI7/T	32mm	20mm	Transparent	•	
CLI7/Z	32mm	20mm	Black	•	

CLI22 - CLI22/B

Clear snail clip with or without adhesive back.

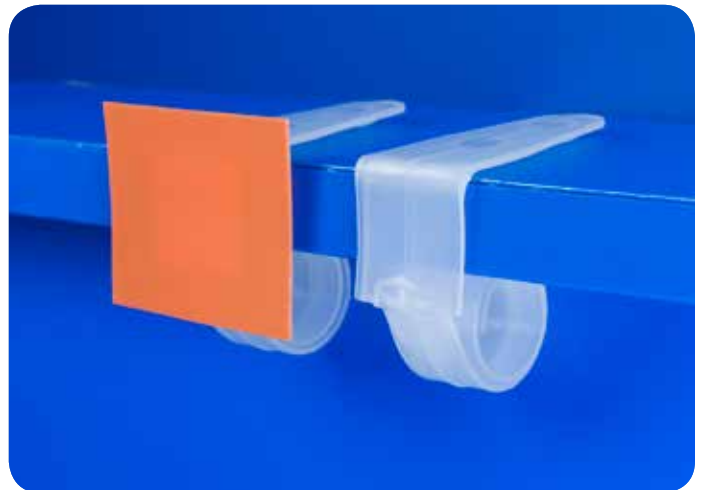
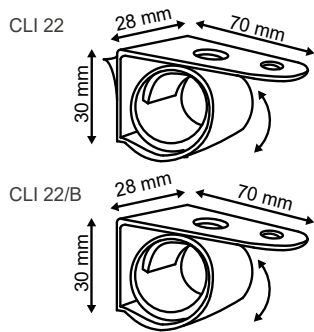

	H	W	ADHESIVE	<input checked="" type="checkbox"/>	
CLI22	30mm	70mm	/	•	
CLI22/B	30mm	70mm	Permanent	•	

HAN33 - HAN33/B

White plastic shelf clip with a hook.

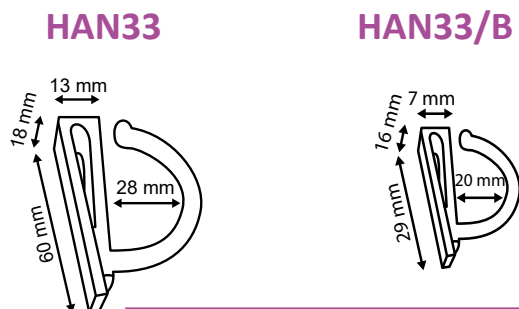

	H	W	<input checked="" type="checkbox"/>	
HAN33	60mm	13mm	•	
HAN33/B	29mm	7mm	•	

L → length | W → width | H → height | Ø → diameter | → capacity | → stock | → on request

SUP21

Clear flexible shelf clip with a gripper.

→ Supplied on request.

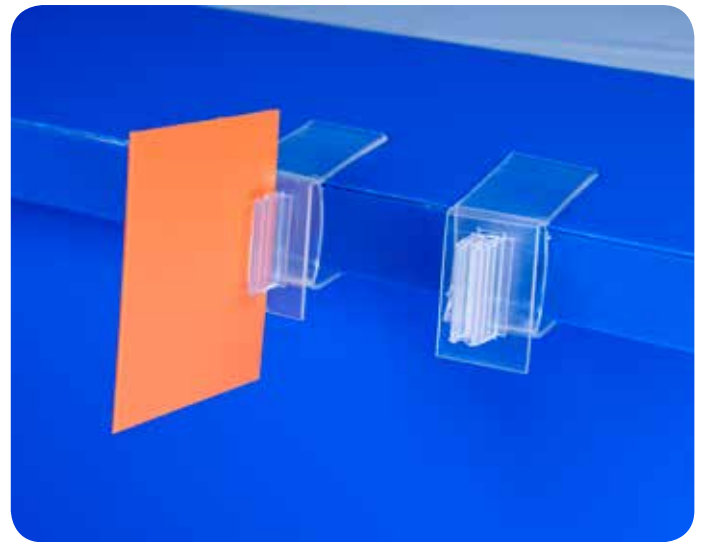
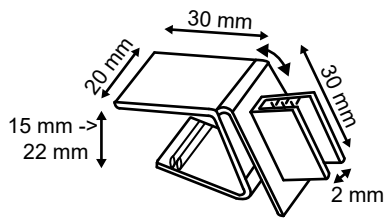

	H	W	<input checked="" type="checkbox"/>	
SUP21	30mm	30mm		•

LEA24

Natural polypropylene coupon holder available in different capacities or fixations.

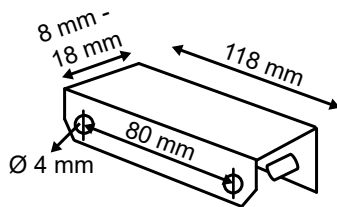

	L	CAPACITY	FIXATION	<input checked="" type="checkbox"/>	
LEA24/18	118mm	18mm	Supergrip	•	
LEA24/18MMT	118mm	18mm	Foam Tape	•	
LEA24/18ZS	118mm	18mm	Without fixation	•	
LEA24/8	118mm	8mm	Supergrip	•	
LEA24/8MMT	118mm	8mm	Foam Tape	•	
LEA24/8ZS	118mm	8mm	Without fixation	•	

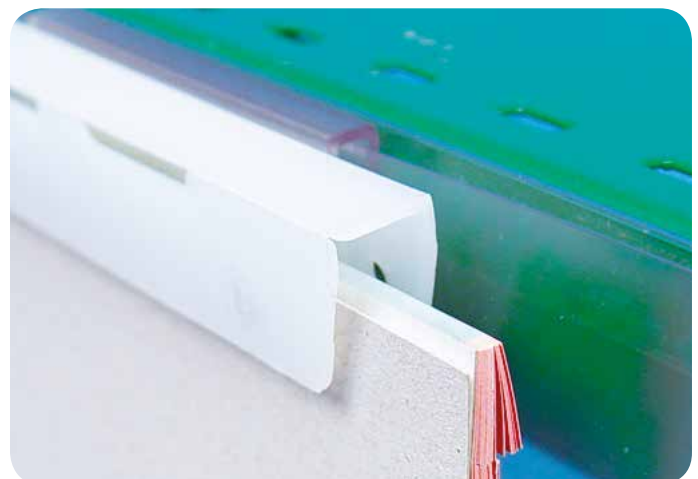

L → length | W → width | H → height | Ø → diameter | → capacity | → stock | → on request

2.6 Banner holders

Banner holders are an excellent way to enable your messages being seen by customers in an aisle or shelf situation. Our range provides endless possibilities of adjusting, holding and hanging your ads and messages efficiently.

BAN11

Magnetic undershelf bracket with a supergrip.

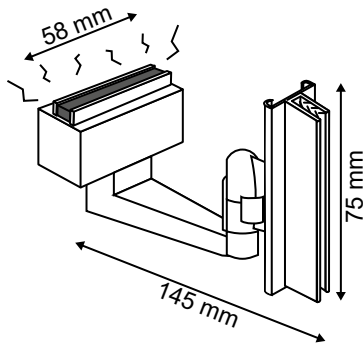

	L ARM	GRIP	MEDIA FIXATION	BAN FIXATION	<input checked="" type="checkbox"/>	
BAN11	145mm	75mm	Supergrip	Magnet	●	

BAN12

Magnetic telescopic L-shaped banner holder with 2 clips.

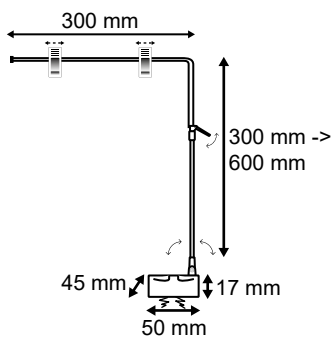

	L ARM	H ARM	MEDIA FIXATION	BAN FIXATION	<input checked="" type="checkbox"/>	
BAN12	300mm	300 to 600mm	Clips	Magnet	●	

BAN1 - BAN1/470

Banner holder in metal with 2 magnets, 2 metal hooks and an end cap.

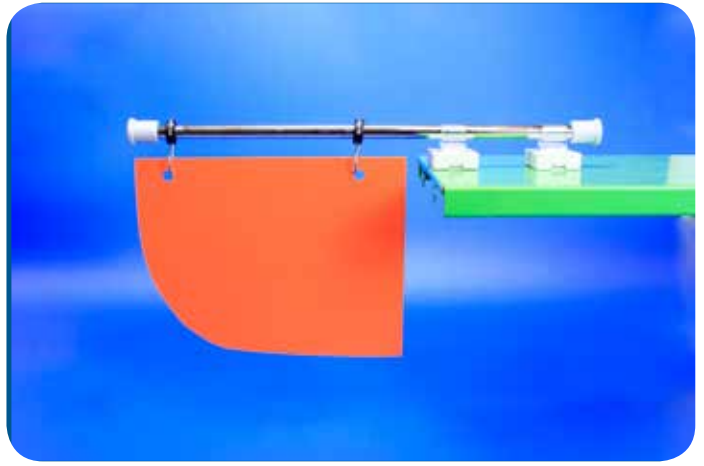
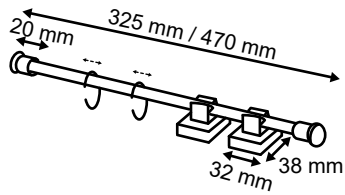

	L ARM	MEDIA FIXATION	BAN FIXATION	<input checked="" type="checkbox"/>	
BAN1	325mm	C hooks	Magnet		•
BAN1/470	470mm	C hooks	Magnet		•

BAN1/C

White plastic banner holder with a magnet and 2 adjustable oval plastic rings.

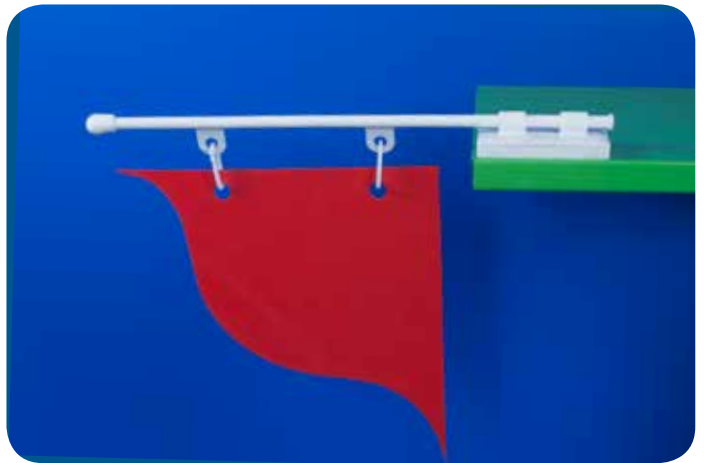
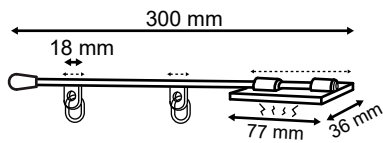

	L ARM	MEDIA FIXATION	BAN FIXATION	<input checked="" type="checkbox"/>	
BAN1/C	300mm	Oval rings	Magnet	•	

BAN1/D

White plastic banner holder with 2 adhesive pads and 2 adjustable oval plastic rings.

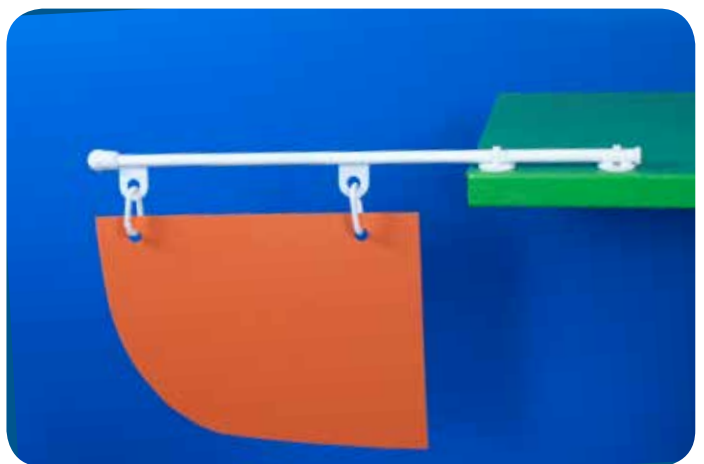
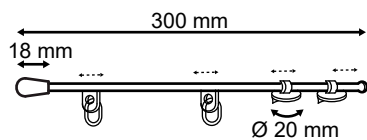

	L ARM	MEDIA FIXATION	BAN FIXATION	<input checked="" type="checkbox"/>	
BAN1/D	300mm	Oval rings	Adhesive pads	•	

BAN13

Magnetic L-shaped banner holder with 2 plastic hooks.

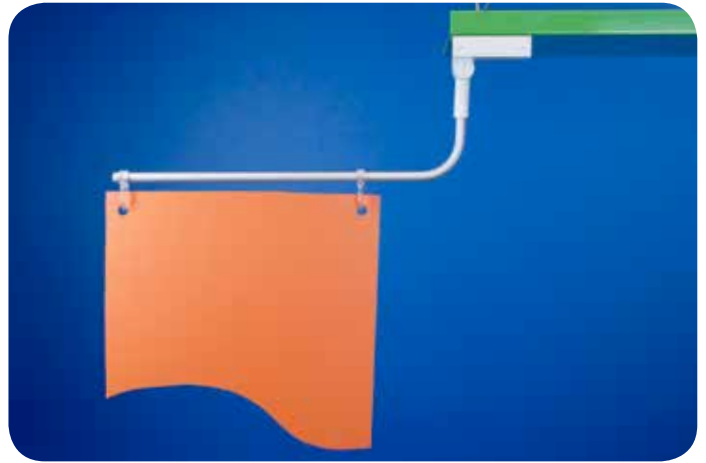
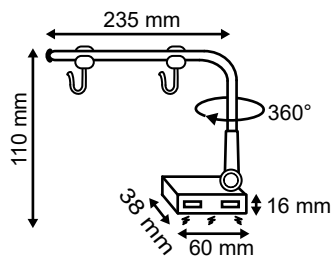

	L ARM	H ARM	MEDIA FIXATION	BAN FIXATION	<input checked="" type="checkbox"/>	
BAN13	235mm	110mm	Hooks	Magnet	•	

3 adjustable parts to fit everywhere



MAG20

Magnetic banner holder with an adjustable clear clip.

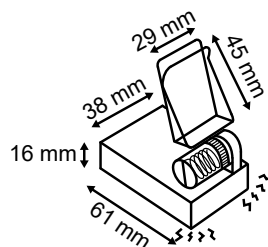

	L	W	MEDIA FIXATION	BAN FIXATION	<input checked="" type="checkbox"/>	
MAG20	61mm	38mm	Ticket Holder	Magnet	•	

BAN4/V - BAN4/H

Magnetic banner holder that can be used in vertical or horizontal way. Only supplied on request.

	L ARM	BAN FIXATION	<input checked="" type="checkbox"/>	
BAN4/V	110mm	Magnet		•
BAN4/H	110mm	Magnet		•



BAN4/V

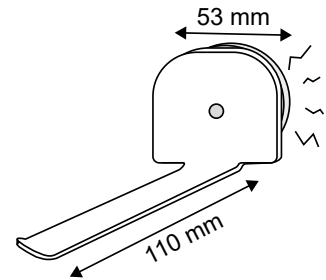

BAN4/H

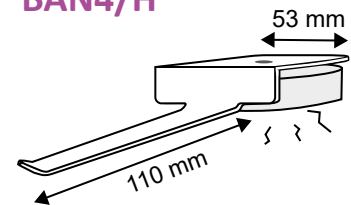

Free (*) Samples !

You have decided to purchase a product from our range. However you still hesitate if it's the right product for your display and whether it will suit your needs....

In this case we can send you some free samples for you to carry out a relevant test.

→ Any samples will be sent to you for free, provided their gross value does not exceed (*) 5,- € (inclusive of VAT).

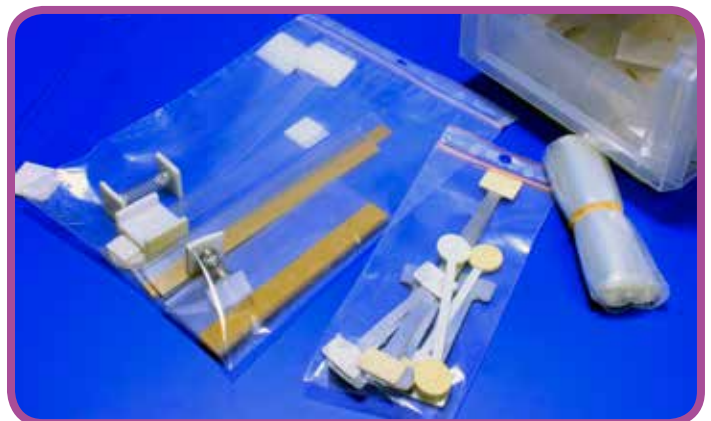

Any samples requests are welcome

export@all-round.be

RAZ2

Magnetic banner holder with an adjustable clear clip.
 → Custom lengths supplied on request.

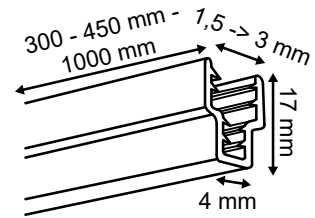

	L	H	CAPACITY	<input checked="" type="checkbox"/>	
RAZ2/01	300mm	17mm	1.5mm to 3mm	•	
RAZ2/02	450mm	17mm	1.5mm to 3mm	•	
RAZ03/03	1000mm	17mm	1.5mm to 3mm	•	

RAZ4

Magnetic bottom in ABS for reference RAZ2.
 Can be used in vertical or horizontal position.

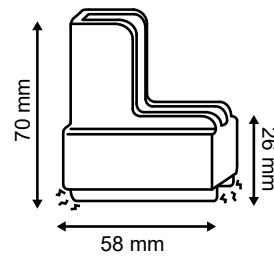

	L	H	COLORS	<input checked="" type="checkbox"/>	
RAZ4/03W	58mm	70mm	White	•	
RAZ4/04B	58mm	70mm	Black	•	

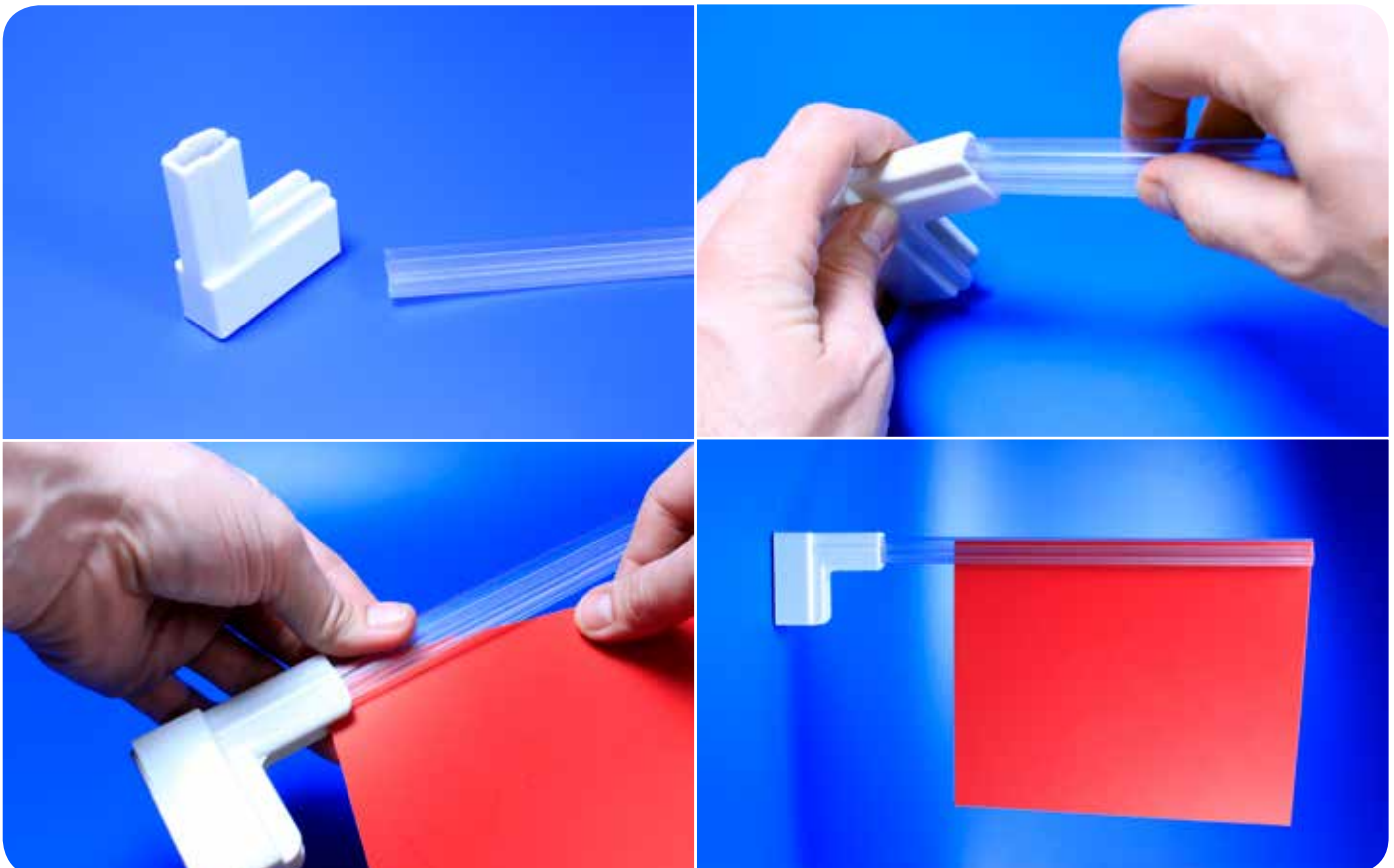

2.7 Label holders

Label Holders are one of our most popular ranges widely used throughout retail shelves to display prices, barcodes and other information. They are UV resistant and easy to scan. They can be supplied with or without tape.

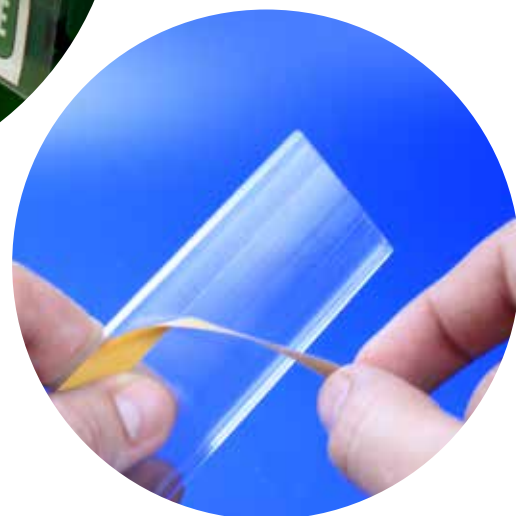

LAB4

Label holder in PVC, with or without adhesive. Standard colors: transparent and white.

→ Different colors and lengths on demand.

	OVERALL H	TICKET H	<input checked="" type="checkbox"/>	
LAB4/18	18mm	15mm		•
LAB4/24	24mm	21mm		•
LAB4/26	26mm	23mm		•
LAB4/30	30mm	27mm	Quick Lead Time*	
LAB4/39	39mm	36mm	Quick Lead Time*	
LAB4/55	55mm	52mm	Quick Lead Time*	
LAB4/64	64mm	61mm		•
LAB4/73	73mm	70mm		•
LAB4/80	80mm	77mm		•

*Can be cut to size from 140mm length for a quantity under 1000 units.

L → length | W → width | H → height | Ø → diameter | → capacity | → stock | → on request

LAB7

Clear PVC label holder for double display prong.
 → Custom lengths supplied on request.

	L	OVERALL H	TICKET H	<input checked="" type="checkbox"/>	
LAB7/65	65mm	39mm	36mm	<input type="checkbox"/>	<input type="checkbox"/>
LAB7/78	78mm	24mm	21mm	<input type="checkbox"/>	<input type="checkbox"/>

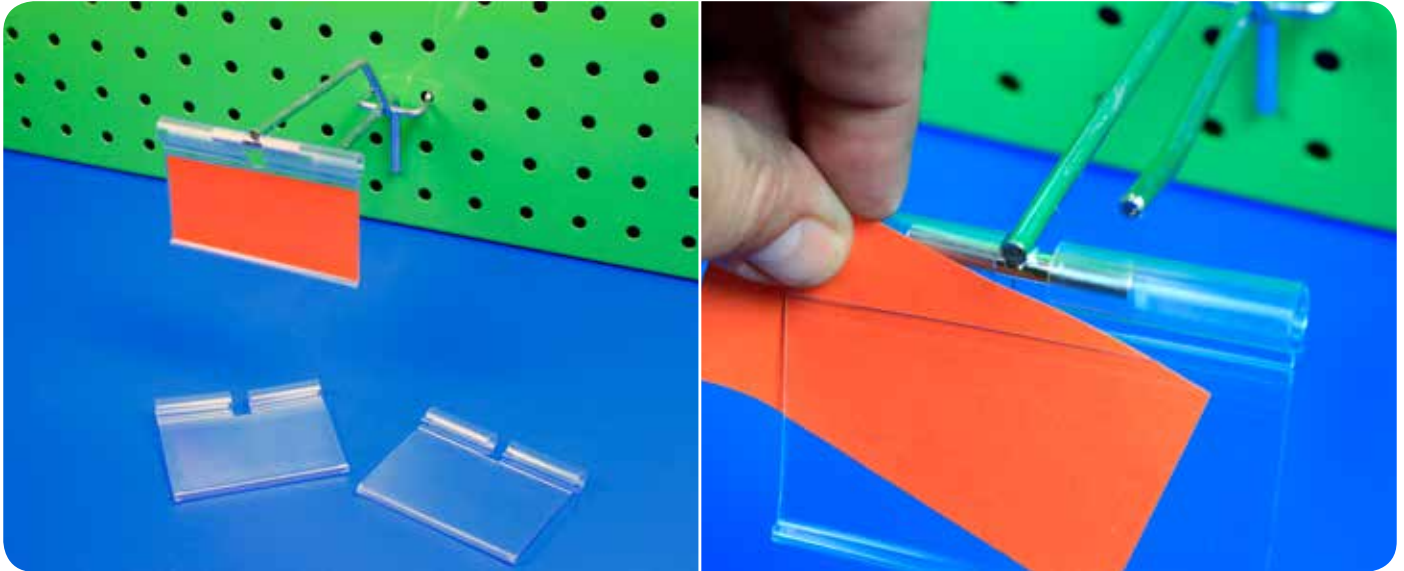
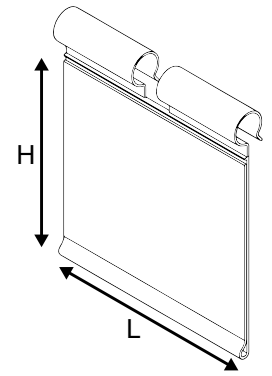

2

LAB8

Clear PVC Label holder for glass shelf, with or without tape.
 Available color: transparent
 → Only supplied on request.

	OVERALL H	TICKET H	<input checked="" type="checkbox"/>	
LAB8/26	26mm	23mm	<input type="checkbox"/>	<input type="checkbox"/>
LAB8/39	39mm	36mm	<input type="checkbox"/>	<input type="checkbox"/>

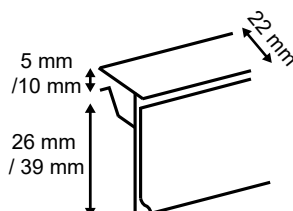

LAB9

Top mount and bottom holder with adhesive back to display poster, signage, media on cardboard displays.

→ Custom lengths on request

	L	H1	H2	<input checked="" type="checkbox"/>	
LAB9/30	30mm	16mm	10mm	●	
LAB9/45	45mm	16mm	10mm	●	
LAB9/100	100mm	16mm	10mm	●	

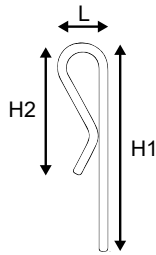

LAB10

Clear PVC Label holder with or without tape for wire basket or glass shelf.

→ Supplied on request.

	OVERALL H	TICKET H	<input checked="" type="checkbox"/>	
LAB10	39mm	36mm		●

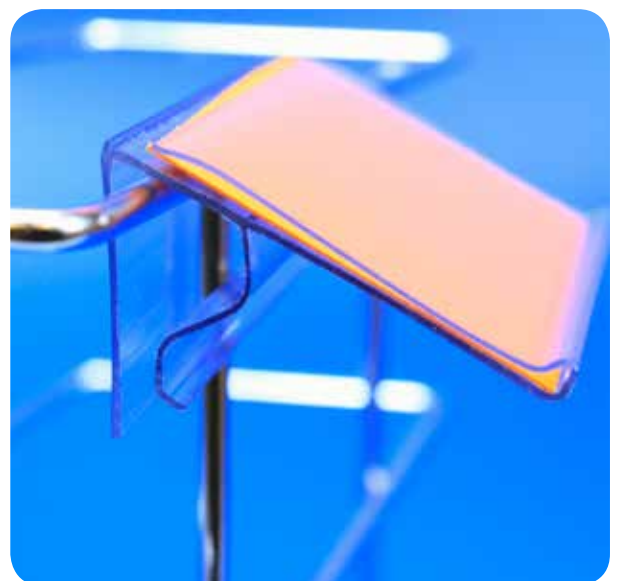
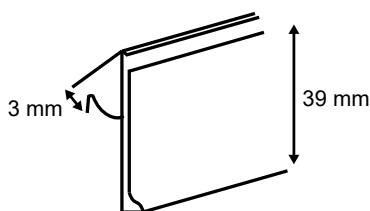

LAB11

Clear PVC label holder with 2 perforation holes for attaching to wire baskets or racking's.

→ Can be used with our cable tie reference DIS 18.

	L	OVERALL H	TICKET H	<input checked="" type="checkbox"/>	
LAB11/10	100mm	39mm	36mm	<input type="checkbox"/>	<input type="checkbox"/>
LAB11/100	1000mm	39mm	36mm	<input type="checkbox"/>	<input type="checkbox"/>

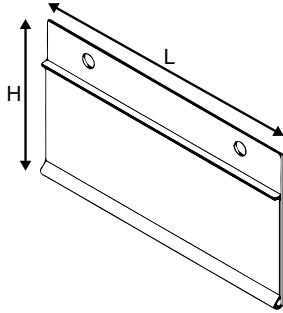

LAB12

Clear PVC Label holder for Tegometall shelves.

→ Supplied on request.

	OVERALL H	TICKET H	<input checked="" type="checkbox"/>	
LAB12	39mm	36mm	<input type="checkbox"/>	<input type="checkbox"/>

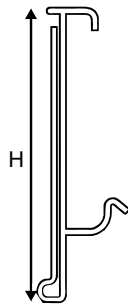

LAB13

Clear round PVC label holder with adhesive back. Tickets are being inserted into the curved front. Adheres to the top surface of shelf and acts as a light weight stock barrier.

→ Only supplied on request.

	OVERALL H	TICKET H	<input checked="" type="checkbox"/>	
LAB13	39mm	36mm	<input type="checkbox"/>	<input type="checkbox"/>

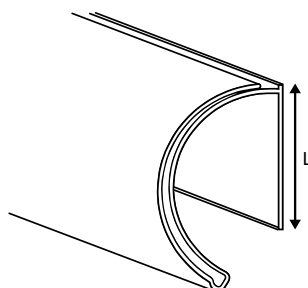

LAB15

Clear PVC flexible label holder.

Hinges for easy access to products by customers.

	L	OVERALL H	TICKET H	<input checked="" type="checkbox"/>	
LAB15/100	100mm	80mm	73mm	●	
LAB15/150	150mm	80mm	73mm	●	
LAB15/200	200mm	80mm	73mm	●	

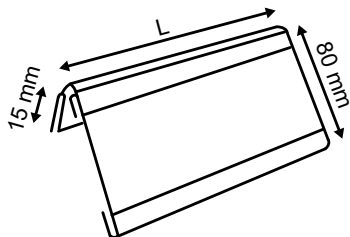

LAB17

Clear PVC pocket used for tablets.

Adjustable for glass / wood / metal.

	H	L	W	<input checked="" type="checkbox"/>	
LAB17	50mm	210mm	200mm	●	

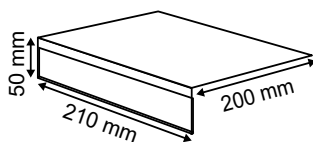

LAB22/300

Clear plastic protection strip for glass shelves.

→ Custom lengths on request.

	L		UPPER / LOWER	<input checked="" type="checkbox"/>	
LAB22/300	300mm	6mm	29 / 24mm	●	

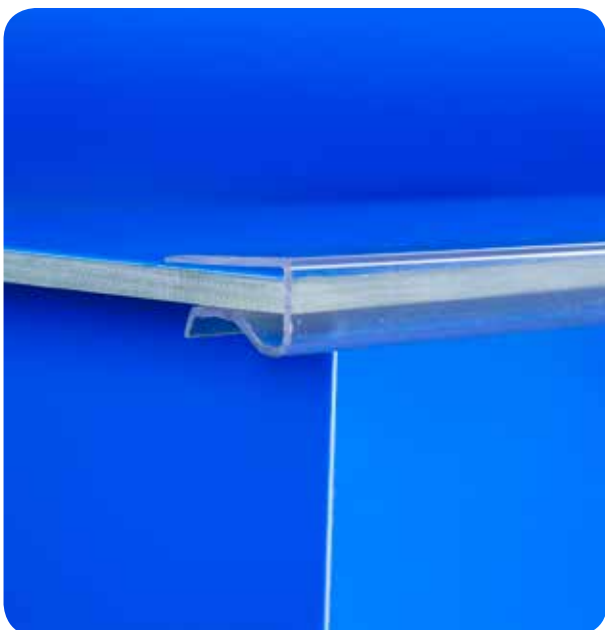
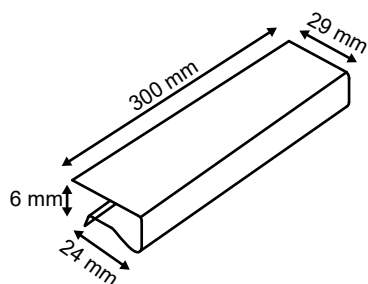

2.8 Hang Strips

Hang Strips enable previously unused areas to create impulse buys. Products thereby become highly visible and easy to pick.

We suggest to put Hang Strips in following areas of the shops: check out points, shelf edges, chiller cabinets, store columns. They offer further space for customizing and branding.

Hang Strips are available in a wide variety of styles, thicknesses and sizes. They can be pre-cut, on reels, with loose headers, ...

Hang Strips features:

- *Maximum utilization of retail selling space*
- *Impulse purchase opportunities*
- *High visual impact*
- *Cross selling opportunities*
- *New product launches*

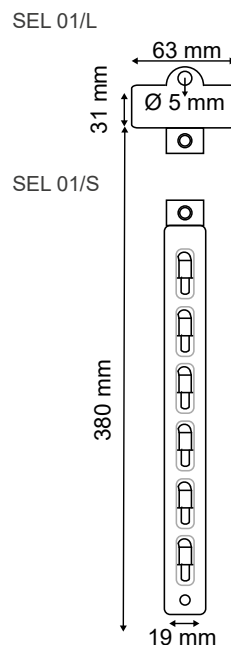

SEL1/S - SEL1/L

White polypropylene hang strip with 6 clips (SEL1/S) + header (SEL1/L). Self-assembly.

	L	W	CLIPS	<input checked="" type="checkbox"/>	
SEL1/S	380mm	19mm	6	•	
SEL1/L	63mm	31mm	/	•	

L → length | W → width | H → height | Ø → diameter | → capacity | → stock | → on request

SEL1

White polypropylene injection moulded hang strip with 12 clips and a header.

	L	CLIPS	<input checked="" type="checkbox"/>	
SEL1	740mm	12	<input type="checkbox"/>	<input type="checkbox"/>



SEL2

Clear polypropylene hang strip with 12 hooks.
 → Custom lengths on request.

	L	CLIPS	THICKNESS	COLOR	<input checked="" type="checkbox"/>	
SEL2/151	590mm	12	630μ	Clear	<input type="checkbox"/>	<input type="checkbox"/>
SEL2/182	590mm	12	500μ	Clear	<input type="checkbox"/>	<input type="checkbox"/>

SEL1

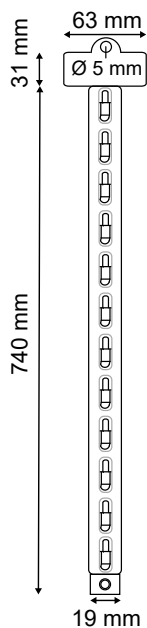

SEL2

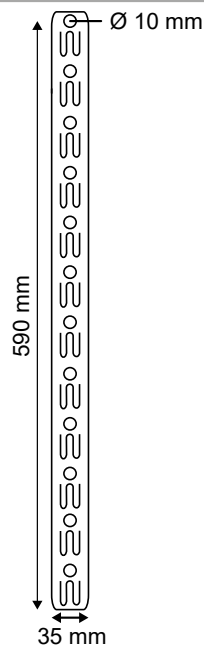

L → length | W → width | H → height | Ø → diameter |  → capacity | → stock |  → on request

SEL3

Metal hang strip with 12 clips, a header and suspension hook.

	L	CLIPS	COLOR	<input checked="" type="checkbox"/>	
SEL3	750mm	12	Metal	•	

SEL4

Clear polypropylene injection molded foldable hang strip with 12 clips and a header.

	L	CLIPS	COLOR	<input checked="" type="checkbox"/>	
SEL4	600mm	12	Clear	•	

SEL9

Clear polypropylene hang strip with 10 clips and a header.

	L	CLIPS	COLOR	<input checked="" type="checkbox"/>	
SEL9	600mm	10	Clear	•	

SEL3

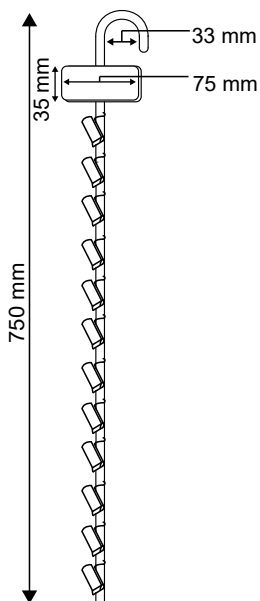

SEL4

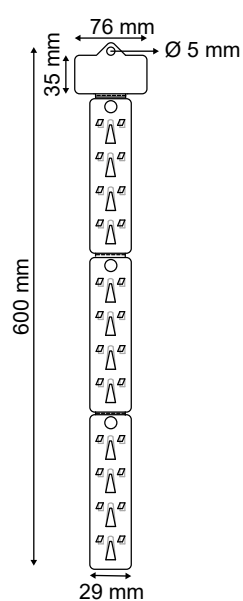

SEL9

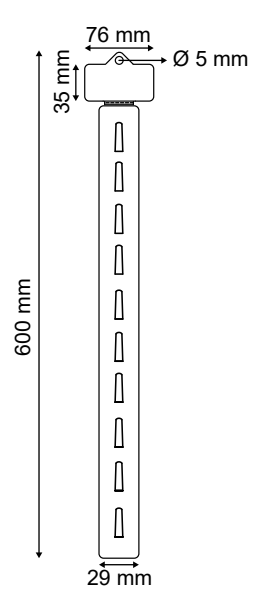

SEL5

Clear polypropylene die cut hang strip with 12 clips and a header.

	L	THICKNESS	CLIPS	COLOR	<input checked="" type="checkbox"/>	
SEL5	600mm	500μ	12	Clear	•	

SEL6

Clear polypropylene die cut hang strip with 12 clips and a large header.

	L	THICKNESS	CLIPS	COLOR	<input checked="" type="checkbox"/>	
SEL6	600mm	800μ	12	Clear	•	

SEL11

Clear polypropylene double-sided hang strip with 12 clips on both sides.

	L	CLIPS	COLOR	<input checked="" type="checkbox"/>	
SEL11	720mm	2x12	Clear	•	

SEL5

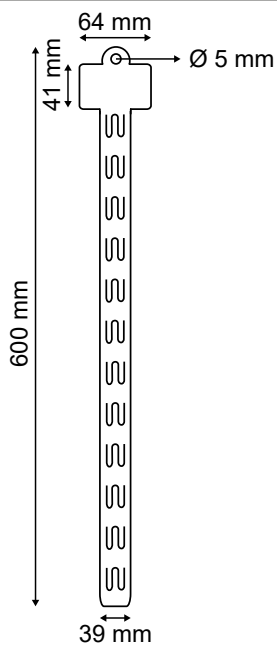

SEL6

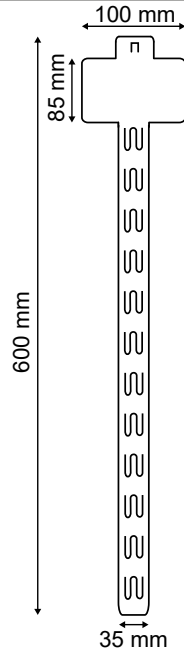

SEL11

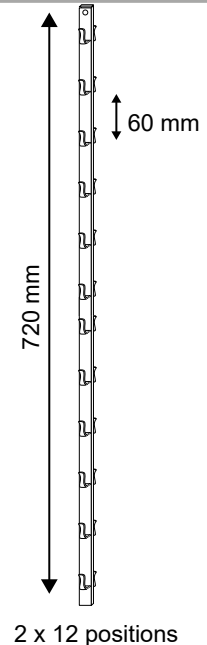

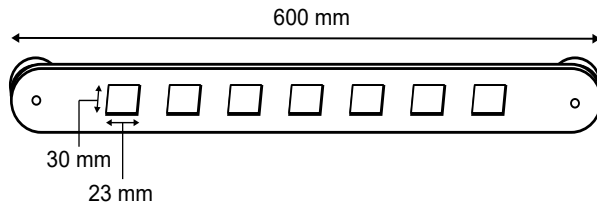

SEL12

White polystyrene cross merchandising strip with 2 large magnets and 7 positions.
Can be used in vertical or horizontal way.

→ Supplied on request.

	L	W	THICKNESS	CLIPS	COLORS	<input checked="" type="checkbox"/>	
SEL12	600mm	50mm	800µ	7	White		<input type="checkbox"/>



L → length | W → width | H → height | Ø → diameter | → capacity | → stock | → on request

2.9 Hang Strip accessories

Hang Strips can be fixed to shelves or aisles by means of a variety of accessories: metal or plastic hooks, attachments cords, suction cups and many more.

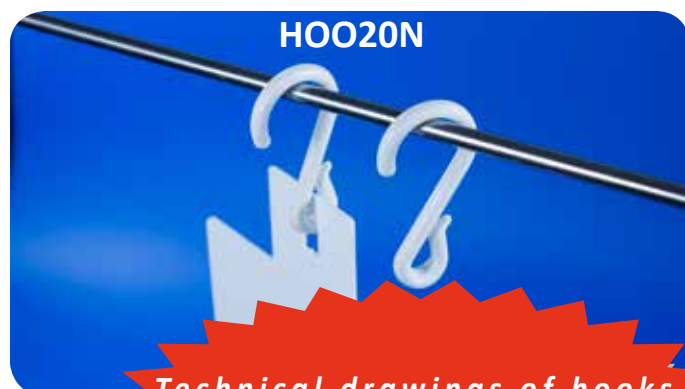

Technical drawings of hooks available on p 140

HOO3 - HOO17 - HOO18 - HOO20N

Hook with a crimped end to hang up hang strips.

	H	WIRE Ø	COLORS	<input checked="" type="checkbox"/>	
HOO3	39mm	2mm	Metal	•	
HOO17	45mm	2.5mm	Metal	•	
HOO18	45mm	4mm	Metal	•	
HOO20N	49mm	4mm	White Nylon	•	

HOO10

Metal shelf-top hook to hang hang-strips in flag position.

	L	Ø	<input checked="" type="checkbox"/>	
HOO10	100mm	3.7mm	•	

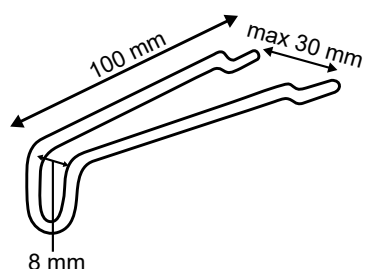

L → length | W → width | H → height | Ø → diameter | → capacity | → stock | → on request

2.10 Hang Strips on request

All Round encourages enquiries from organizations who have specific difficulties with pack hanging and point of sale accessory products. New product concepts can be turned round quickly in conjunction with prototype samples of production quality.

Heavy, bulky, odd shaped products sometimes have no means to be hung... Whatever your product dictates, a solution is possible.

By sending us a product sample, we can manufacture a relevant prototype in a very short time.





L → length | W → width | H → height | Ø → diameter |  → capacity | → stock |  → on request

3. Ticket Accessories

Your clients and staff like to see all product information at once: names, prices, technical specs and bar codes. Within the ticket accessories' category, you will find a handy mounting system for each label of any product that makes this information clearly visible.

Fixing tags in nylon or polypropylene are a simple example. They make sure you can attach all information firmly to your products by means of attachment cords, cable or zip ties. Metal clamps are another option.

If the information needs to stand out, you can opt for card holders. Within this product range, there are plenty of possibilities: magnetic, adhesive or with a hanging system. Or do you consider spikes, clamps or clips? We propose a tailor-made solution based on your product information.

Do you sell products made of precious or fragile materials? Then we offer a unique solution to attach information to these. Transparent fix-twists allow you to attach all information and promotion properly to the surface, without the risk of leaving stains or damage afterwards.

Our suction cups are also available in different versions: with or without a screw, with a metal hook, with a small pin or a suction cup with a ring. This allows you to attach (almost) everything by means of a suction cup.

And please don't forget: every now and then you also have to sell yourself ! Clients like to know who is who in your company and on professional trade shows it's obvious that your logo and position should be visible. Badge holders are an excellent choice for this.

Would you like to receive more information about this extensive range? Don't hesitate to contact us if you want any clarification and a proposal that perfectly suits your needs.

3.1 Attachments

3.2 Supergrips

3.3 Pen-holders

3.4 Hanging clips

3.5 Fix-Twist

3.6 Wire basket ticket holders

3.7 Supergrip for cardboard / display construction

3.8 Supergrip with hinge

3.9 Supergrip with suction cup

3.10 Ticket holders

3.11 Polystyrene Ticket Holders

3.12 POS-Clips assembly spare parts

3.13 Suction cups

3.14 Badge holders

3.1 Attachements

Attachments, cords and cable ties are an excellent means of holding tags, signs and banners firmly in place. They also secure sell strips and signage to wire baskets. They are available in various sizes and styles. All of them are made from clear flexible nylon or polypropylene.

ATT16 - ATT17

ATT16: Plastic gun to attach nylon tags – for normal fabrics. Its ergonomic design and easy-squeeze mechanism make it “the number one” choice for tagging applications. This accepts 50 fastener clips.

ATT17: Pack of 5 regular needles to go with tagging gun. All needles are precision-crafted with a round tip and a smooth exact profile to prevent snagging.



	L	∅	☑	🛒
ATT16	To be used with reference ATT17/DN		●	
ATT17/DN	20mm	1.8mm	●	



L → length | W → width | H → height | ∅ → diameter | ☑ → stock | 🛒 → on request

ATT5

Clear nylon / polypropylene attachment with a large flat end. Standard lengths available from stock.
 → Custom lengths on request.

	L	✓	🛒
ATT5/NY15W	15mm	•	
ATT5/NY20W	20mm	•	
ATT5/NY25W	25mm		•
ATT5/NY40W	40mm	•	
ATT5/NY50W	50mm		•
ATT5/NY65W	65mm	•	
ATT5/NY125W	125mm	•	
T Ends:	One end: 9mm Other end: 10mm		



ATT6

Clear nylon / polypropylene attachment with narrow end.

	L	✓	🛒
ATT6/13	13mm	•	
ATT6/25	25mm	•	
ATT6/125	125mm	•	
T Ends:	One end: 9mm Other end: 10mm		



ATT7

Clear nylon / polypropylene attachment with double arms.
 → Only supplied on request.

	L	✓	🛒
ATT7	65mm		•
T Ends:	One end: 9mm Other end: 10mm		

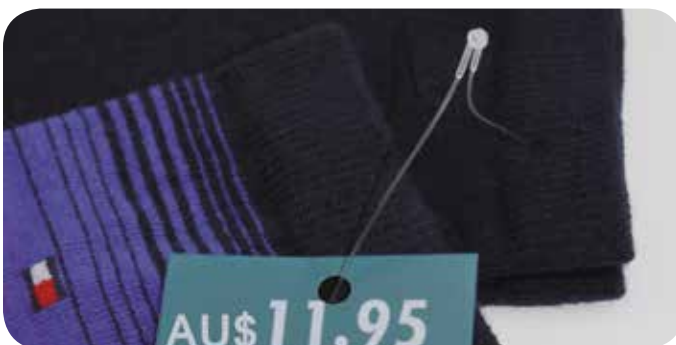
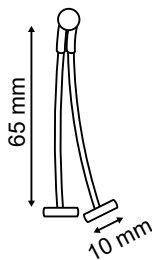

ATT8

Clear attachment with round hook suitable to attach price label. These types of fasteners are ideal for hosiery or head wear items.

	L	✓	🛒
ATT8	53mm	•	

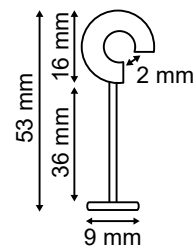

ATT3

Single elastic cord with metal "T end" at both ends.

Different standard colours available.

→ Customs lengths available on request.

	L	COLOR	<input checked="" type="checkbox"/>	
ATT3/150Z	150mm	Black	•	
ATT3/300Z	300mm	Black	•	
ATT3/10-19	100 to 190mm	Different colors		•
ATT3/20-29	200 to 290mm	Different colors		•
ATT3/30-39	300 to 390mm	Different colors		•
ATT3/40-49	400 to 490mm	Different colors		•



ATT9

Transparent attacher cord with fixed loop.

Invisible and extremely discreet.

	L	<input checked="" type="checkbox"/>	
ATT9/75	75mm	•	
ATT9/125	125mm	•	
ATT9/225	225mm	•	



ATT10H

Transparent attacher cord with adjustable loop.

	L	<input checked="" type="checkbox"/>	
ATT10H/125	125mm	•	
ATT10H/225	225mm	•	



ATT18

Textile security loop.

	L	COLOR	☑	🛒
ATT18/120	120mm	White	•	
ATT18/120/Z	120mm	Black	•	
ATT18/200	200mm	White	•	
ATT18/200/Z	200mm	Black	•	

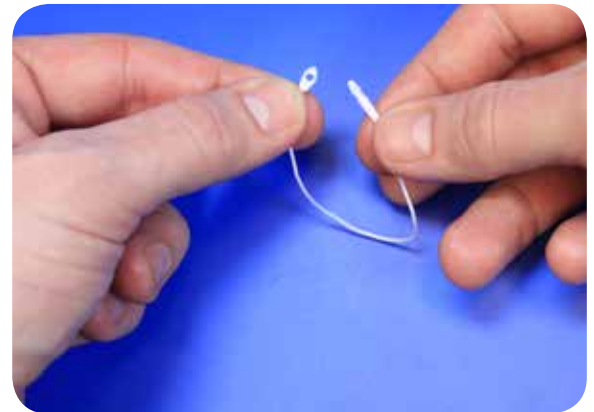
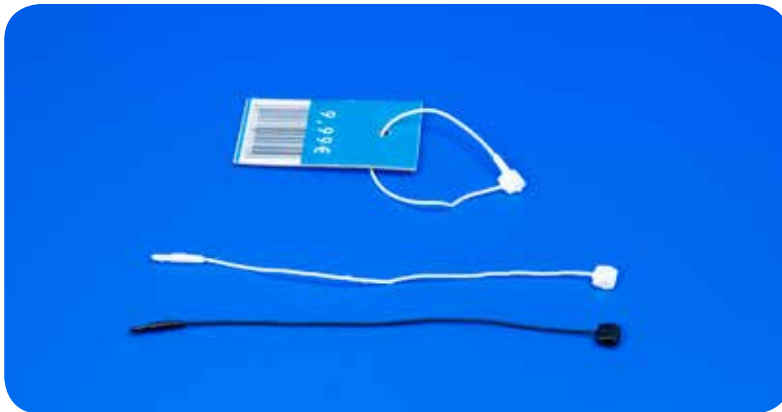

3

ATT11H

Strong and versatile cable ties will hold display items such as Hang Strips or PVC pockets to fixtures.
Permanent tamper proof connection.

	L	W	☑	🛒
ATT11H/100	100mm	2,5mm	•	
ATT11H/145	145mm	3,6mm	•	
ATT11H/200	200mm	2,5mm	•	
ATT11H/300	300mm	4,8mm	•	
ATT11H/370	370mm	5,0mm	•	

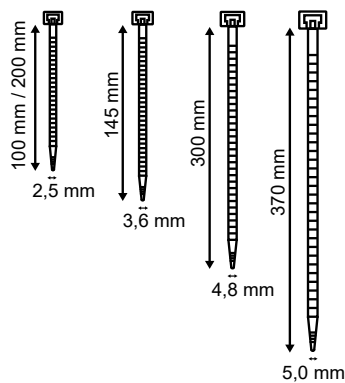
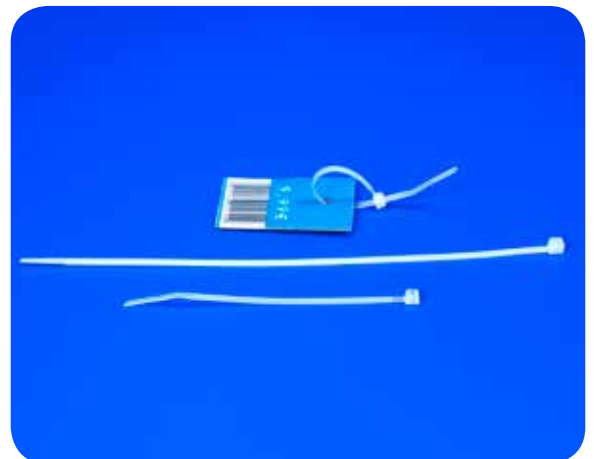

ATT22

Metal security loop with re-closable screw closure.

	∅	<input checked="" type="checkbox"/>	
ATT22/50	50mm	•	
ATT22/250	250mm		•

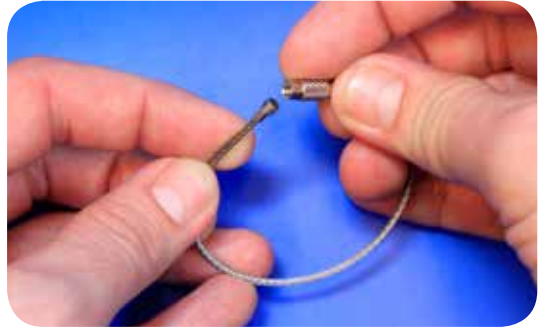

HOO21

Metal display sampling ring.

→ Other sizes supplied on request.

	∅	<input checked="" type="checkbox"/>	
HOO21	152mm	•	



ATT 14

Transparent arrow loop. Used to tag tubes, rods or similar items.
Strong and easy to use.

	L	W	∅	<input checked="" type="checkbox"/>	
ATT14	150mm	10mm	3mm	•	

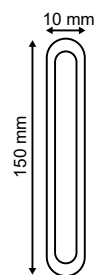

∅ 3 mm



ATT15

Fixed bottle neck ring in neutral or black polypropylene.

→ Supplied on request.

	∅	ARROW	COLOR	<input checked="" type="checkbox"/>	
ATT15/45	45mm	8mm	Clear	<input type="checkbox"/>	•
ATT15/45/Z	45mm	8mm	Black	<input type="checkbox"/>	•

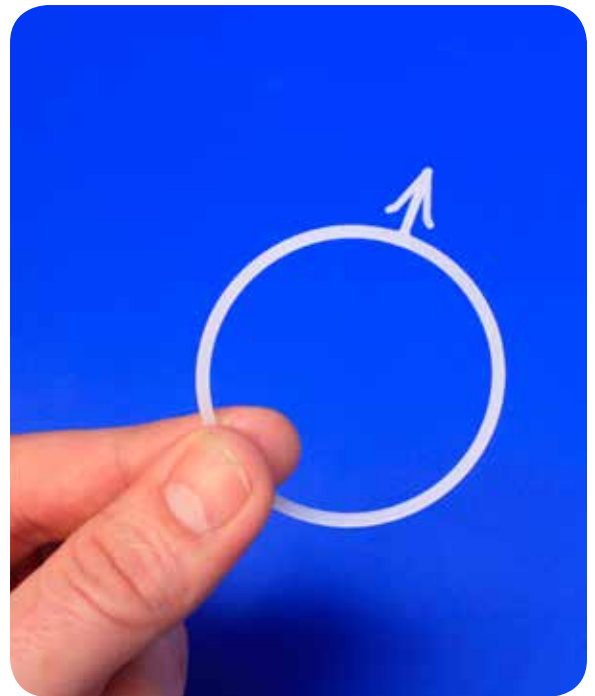

ATT15B

Adjustable bottle neck ring in neutral or black polypropylene.

	∅	ARROW	COLOR	<input checked="" type="checkbox"/>	
ATT15/B	30mm	8mm	Transparent	•	<input type="checkbox"/>
ATT15/B/Z	30mm	8mm	Black	•	<input type="checkbox"/>

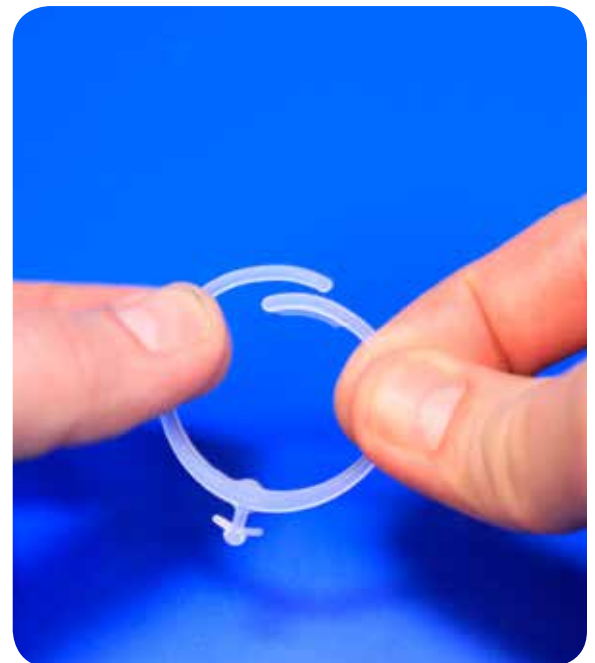

DIS18

Reusable hanging clip in flexible polypropylene for wire basket.

	L	CLIP ∅	<input checked="" type="checkbox"/>	
DIS18	55mm	8.5mm	•	<input type="checkbox"/>

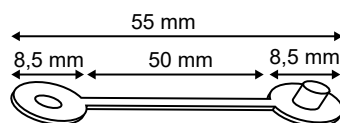

3.2 Supergrips

A range of SUPERGRIPS (ticket holders) allow point-of-sale signs and panels to be displayed in many different ways to suit all applications.

The message fitted to a SUPERGRIP is as important in giving the customer information as the message on the product itself. And if you are not using the right label for the job, then you are not displaying the best message...

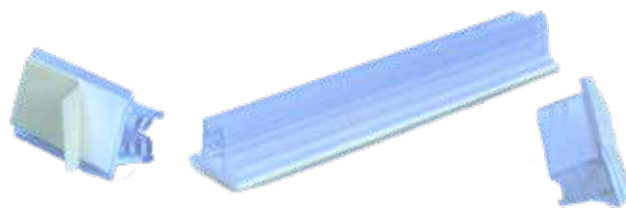

UNCLEAR MESSAGES CAN MEAN LOST SALES.

There are a myriad of ways in which products can be displayed and for every idea there needs to be a pricing label, display panel or SUPERGRIP for the job.

We carry a huge selection of SUPERGRIPS and all you need to do is give us a call to discuss your ideas. Tell us where you need to display the products and we will advise as to the type of SUPERGRIP you need.

SUPERGRIPS are manufactured from super strong transparent PVC and have either an adhesive or non-adhesive base.

4 display types for our Supergrips:

- **Clear PVC card holder with self-adhesive foam base.**

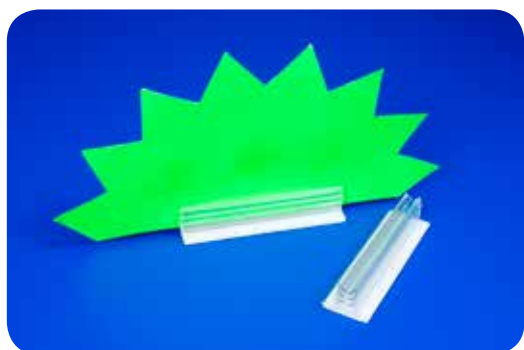

- **Clear PVC parallel supergrip with self-adhesive foam base.**



- **Clear PVC supergrip without adhesive.**



- **Clear PVC card holder with magnetic base.**

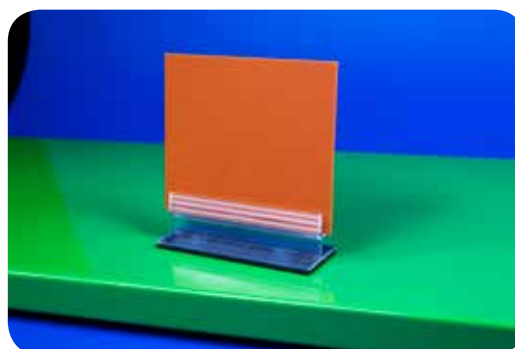

Clear PVC card holder with self-adhesive foam base.

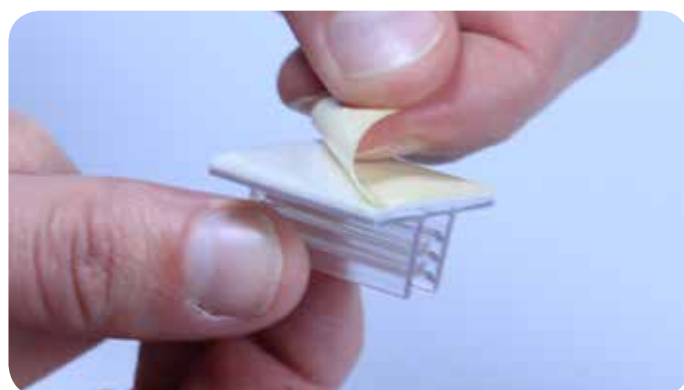
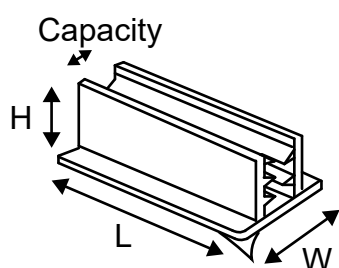
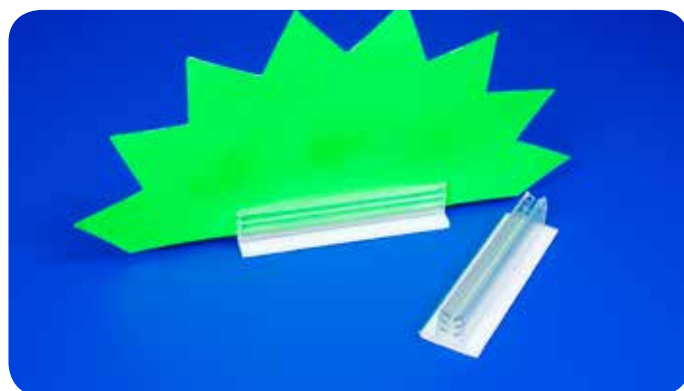

3

	L	W	H	CAPACITY	<input checked="" type="checkbox"/>	
SUP1/15	15mm	12mm	9mm	1mm up to 2mm	●	
SUP1	25mm	12mm	9mm	1mm up to 2mm	●	
SUP2	75mm	12mm	9mm	1mm up to 2mm	●	
SUP1/3	25mm	12mm	9mm	3.5mm	●	
SUP1/50	50mm	12mm	9mm	2mm	●	
SUP4	25mm	25mm	9mm	2mm	●	
SUP5	75mm	25mm	9mm	2mm	●	
SUP7	150mm	25mm	9mm	2mm	●	
SUP5/5	35mm	25mm	18mm	3mm up to 5mm	●	
SUP5/5/35	25mm	25mm	18mm	3mm up to 5mm	●	
SUP8	75mm	20mm	13mm	3mm up to 4mm	●	
SUP9	150mm	20mm	13mm	3 to 4mm	●	
SUP24/75	75mm	25mm	24mm	3 to 6mm	●	
SUP25	75mm	28mm	20mm	3mm		●
SUP26	150mm	28mm	20mm	3mm		●
SUP PP1	25mm	25mm	15mm	0.4mm	●	

L → length | W → width | H → height | Ø → diameter | → capacity | → stock | → on request

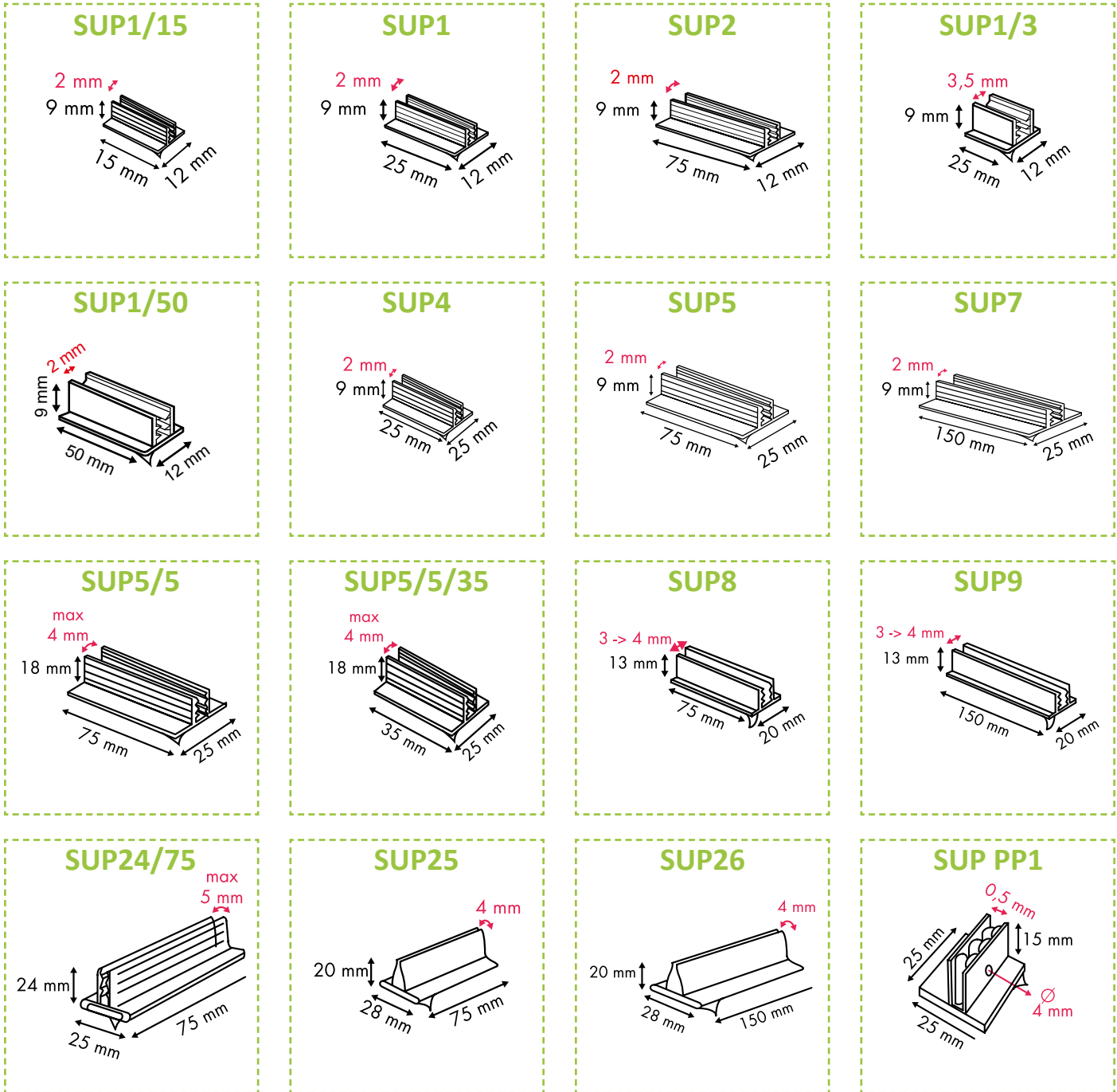

Supergrips available with REMO ONE (removable adhesive)

The removable side removes cleanly from most hard, non delaminating surfaces even after extended periods of time.



⇒ *Supergrip with REMO ONE tape are only available ON REQUEST and are linked to MOQ's and lead times.*

Clear PVC parallel supergrip with self-adhesive foam base.

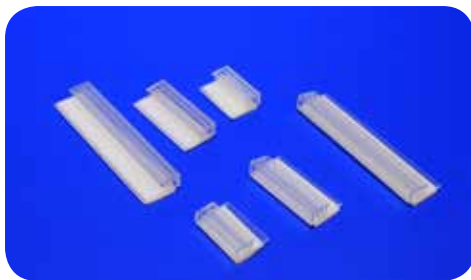

	L	W	H	CAPACITY	☑	🛒
SUP28	25mm	18mm	18mm	1.5mm	●	
SUP29	38mm	18mm	18mm	1.5mm	●	
SUP30	75mm	18mm	18mm	1.5mm	●	

SUP28

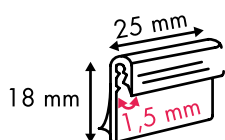

SUP29

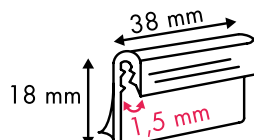

SUP30

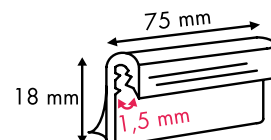

Clear PVC supergrip without adhesive.

	H	L	CAPACITY 1	CAPACITY 2	☑	🛒
SUP39	39mm	21mm	1.5mm	0.5mm up to 1.5mm	●	
SUP40	39mm	20mm	0.5mm up to 2.5mm	0.3mm up to 1.5mm	●	
SUP69	30mm	25mm	1.5mm	0.5mm up to 2mm	●	

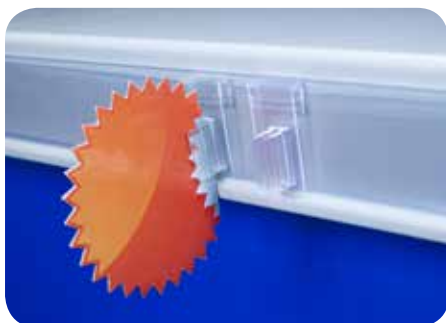

SUP39

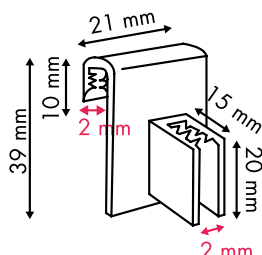

SUP40

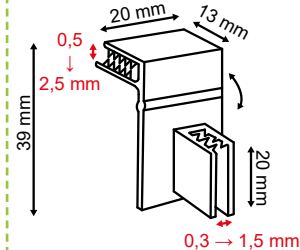

SUP69

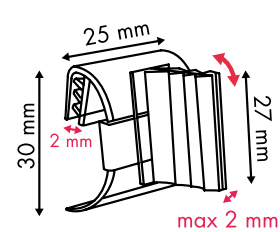

L → length | W → width | H → height | Ø → diameter | → capacity | ☑ → stock | 🛒 → on request

Clear PVC card holder with magnetic base.

	L	W	H	CAPACITY	☑	🛒
SUP7M/75	75mm	25mm	9mm	Max. 2mm	●	
SUP7M	150mm	25mm	9mm	Max. 2mm	●	
MAG7	40mm	30mm	14mm	Max. 2mm	●	
MAG7/5	40mm	30mm	14mm	3mm up to 5mm	●	

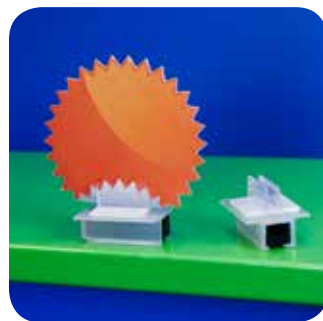

SUP7M/75

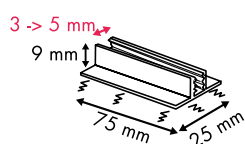

SUP7M

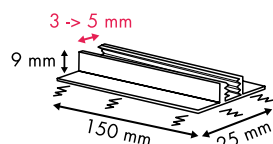

MAG7

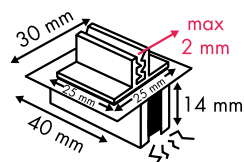

MAG7/5

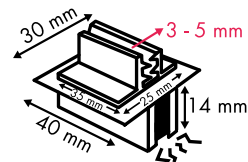

3.3 Pen-holders

For those people who are forever losing a pen or a marker but who needs to be kept in a certain position all the time. This pen clip is just perfect for keeping a pen always where it needs to be.

PEN1

Polypropylene self-adhesive pen-holder in white.

	L	W	H	∩	☑	🛒
PEN1	15mm	12mm	15mm	6mm up to 10mm	●	

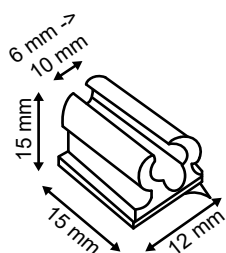

PEN3

Metallic pen clip with foam adhesive.
 → Adjustable to different sizes of pens.

	∅	H		☑	🛒
PEN3	20mm	15mm	6mm up to 14mm	●	

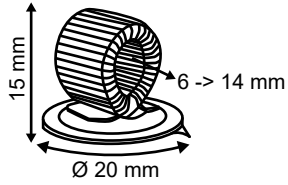

3.4 Hanging clips

CLI10

Metal hanging clip with a perforation hole.

	H	W		☑	🛒
CLI10	40mm	27mm	up to 20mm	●	

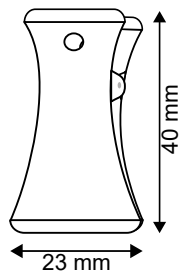

CLI9

Metal hanging clip for a foam board with a capacity up to 6mm.

	H	W		☑	🛒
CLI9	15mm	8mm	up to 6mm	●	

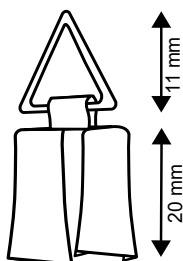

3.5 Fix-Twist

HAN1/RT

Is also called **FIX-TWIST**.

It is actually a ticket button for product labelling.

It has been specially developed to create a secure fixing for labelling high value goods: computers, cookers, freezers, fridges, furniture, office equipment, TV's...

FIX-TWIST is a very small but strong anchor point, yet gentle to the surface of your goods, leaving no marks after use and not damaging painted surfaces.

Sticks on almost every surface: wood, steel, glass, plastic, paper, cardboard,...

The button and adhesive are totally clear. **FIX-TWIST** has got a very high instant adhesion (sticky gel pad with a reliable grip). The button can be removed using the free tool (supplied with your purchase) which helps twist disc off. The twist action loosens the gel pad's grip on the product surface, allowing quick and easy removal... and importantly leaves no marks.

All Round has a range of natural colored security ties to help attach label and tickets to products, as well as PVC pockets.

	Ø	Ø EYE	ADHESION	<input checked="" type="checkbox"/>	
HAN1/RT	22mm	3mm	Removable with key	•	

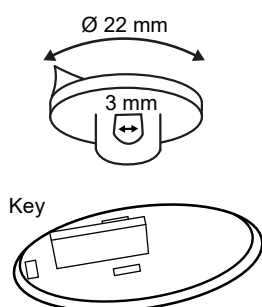

How to remove your Fix-Twist HAN1/RT without any marks?



3.6 Wire basket ticket holders

Retail wire baskets are usually very difficult to be used with a label containing important price or promotional information. A variety of solutions are offered to display the right information on any wire basket used within retail environments.

CLI6/10T

Clear plastic card holder with clamp for wire basket.

L	Ø RING	<input checked="" type="checkbox"/>	
50mm	10mm	●	

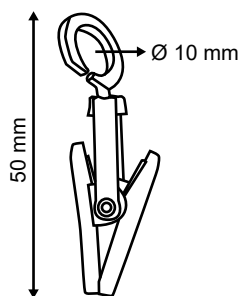

CLI24

White plastic holder for wire basket with foam adhesive.

L	W	<input checked="" type="checkbox"/>	
20mm	20mm	●	

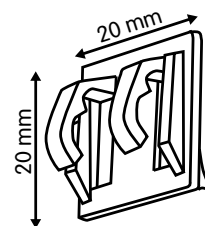

WIN2

White injection molded PP suspension clip for wire basket.

L	W	Ø WIRE	<input checked="" type="checkbox"/>	
45mm	24mm	5mm	●	

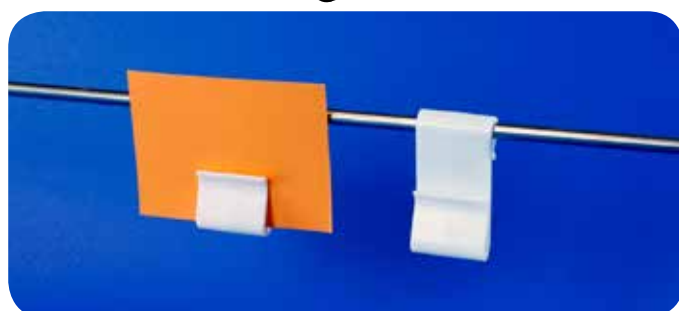
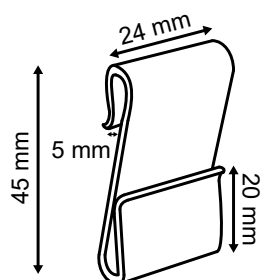

SUP47

Clear PVC card holder for wire basket.

L	W	Ø RING		<input checked="" type="checkbox"/>	
25mm	15mm	9mm	Max. 1.5mm	●	

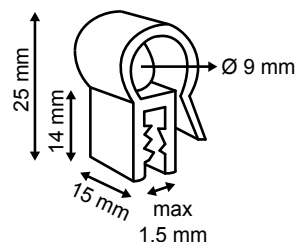

SUP50

White injection molded PP suspension clip for wire basket

L	W	Ø WIRE	┆┆┆	☑	🛒
44mm	35mm	9mm	1.5mm	●	

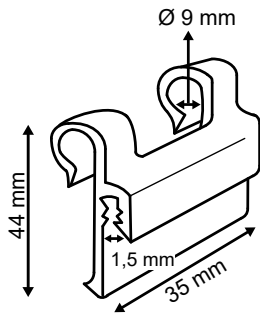

SUP52

Clear PVC perpendicular card holder for wire basket.

L	W	Ø WIRE	┆┆┆	☑	🛒
56mm	25mm	9mm	0.5 up to 2mm	●	

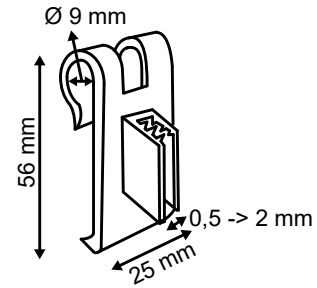

SUP54

Clear PVC card holder for wire basket.

L	W	Ø WIRE	┆┆┆	☑	🛒
17mm	25mm	6mm	Max. 2mm	●	

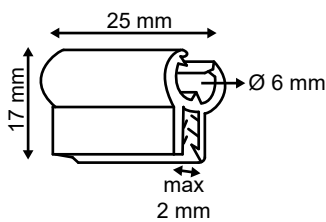

SUP73

Clear PVC supergrip with 2 perforation holes, for hanging application with a capacity up to 2.5mm.

L	W	┆┆┆	☑	🛒
30mm	75mm	Max. 2.5mm	●	

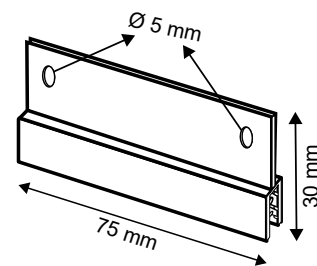

3.7 Supergrip for cardboard / display construction

SUP55

Clear PVC double card holder for cardboard.

	H	W	⇄	☑	🛒
SUP55/01	25mm	25mm	2mm and 6mm	•	
SUP55/38	25mm	38mm	2mm and 6mm	•	

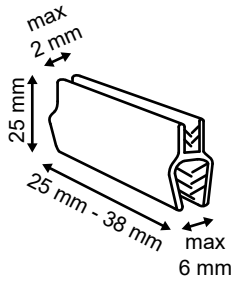

3

SUP56

Clear PVC double card holder.

	H	W	⇄	ADHESIVE	☑	🛒
SUP56	22mm	25mm	Max. 2mm	/	•	
SUP56/A	22mm	25mm	Max. 2mm	•	•	

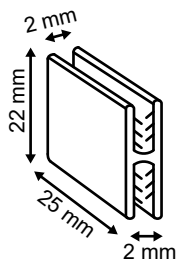

SUP57 - SUP58

Clear PVC two way panel former.

	H	W		ANGLE	<input checked="" type="checkbox"/>	
SUP57	25mm	16mm	Max. 2mm	90°	•	
SUP58	25mm	20mm	Max. 2mm	60°	•	

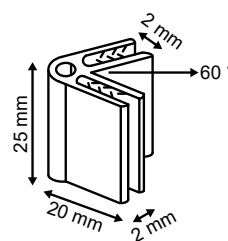
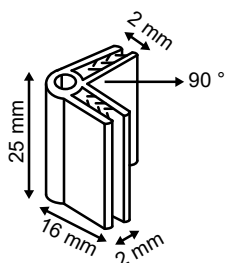
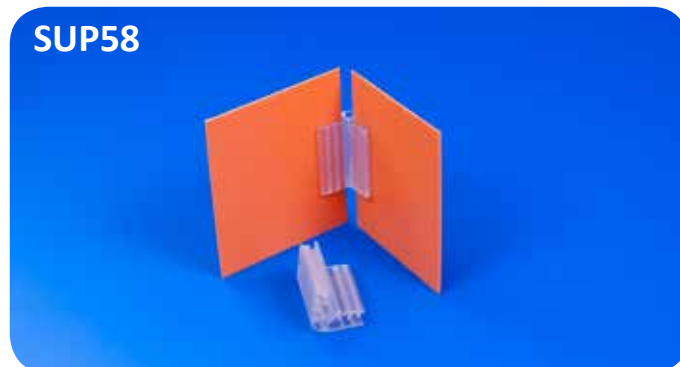
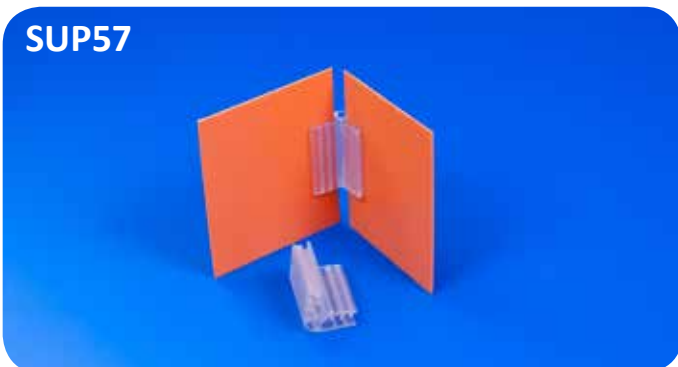

SUP59 - SUP60

Clear PVC multi-way panel former.

	L	W		ANGLE	PANELS	<input checked="" type="checkbox"/>	
SUP59	25mm	22mm	Max. 2mm	120°	3-way		•
SUP60	25mm	13mm	Max. 2mm	90°	4-way	•	

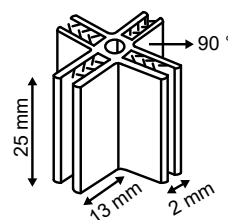
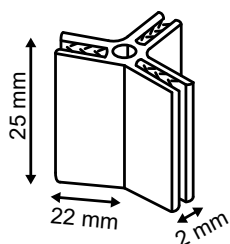
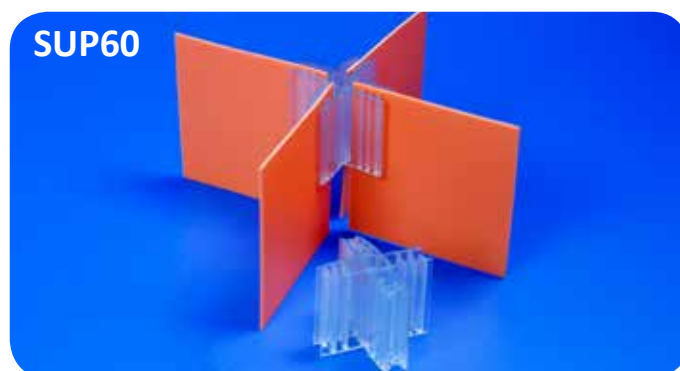
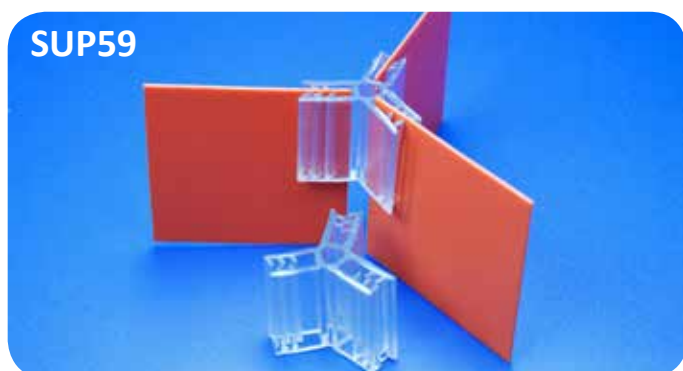

L → length | W → width | H → height | Ø → diameter | || → capacity | → stock |  → on request

3.8 Supergrip with hinge

SUP61/01

Clear PVC hinged two-way panel former.

H	W	↔	☑	🛒
50mm	35mm	2mm up to 3mm	●	

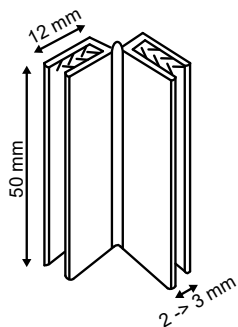

SUP66

Clear PVC hinged card holder with foam adhesive or magnetic base.

	L	W	↔	FIXATION	☑	🛒
SUP66	75mm	25mm	Max. 2mm	Adhesive	●	
SUP66/25	25mm	25mm	Max. 2mm	Adhesive	●	
SUP66M	75mm	25mm	Max. 2mm	Magnetic	●	

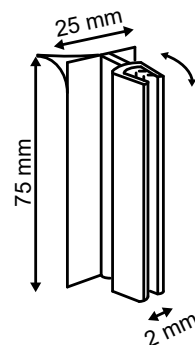
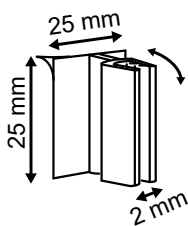
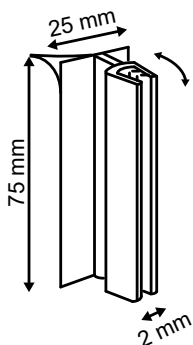
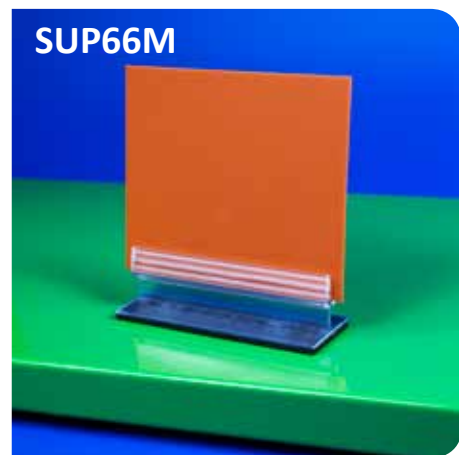

3.9 Supergrip with suction cup

SUP62

Clear PVC gripper with a suction cup.

∅	L	W		☑	🛒
25mm	25mm	15mm	Max. 2mm	●	

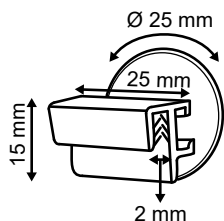

SUP63

Clear PVC perpendicular gripper with a suction cup.

∅	L	W		☑	🛒
25mm	25mm	13mm	Max. 2mm	●	

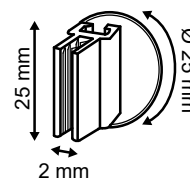

3



SUP77

Clear PVC perpendicular gripper with 2 suction cups.
Self-assembly.

∅	L	H		☑	🛒
40mm	105mm	20mm	0.5mm up to 2mm	●	

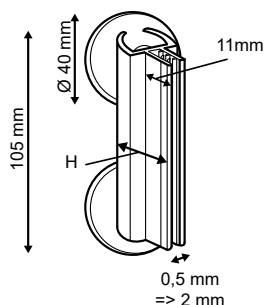

3.10 Ticket holders

Ticket holders can be used in any shop / retail environment where the goods are displayed flat in a shop window. Ticket holders are a perfect use to display prices or promotional information.

TIC7

Clear polystyrene ticket stand with adhesive base.

L	W		☑	🛒
60mm	25mm	1mm	●	

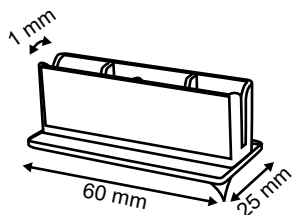

TIC8/B

Clear polystyrene ticket stand.

L	W	H		☑	🛒
60mm	40mm	10mm	1mm	●	

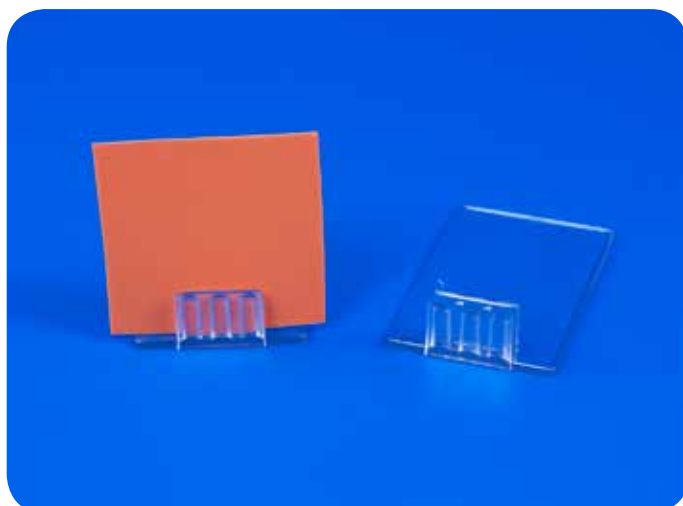
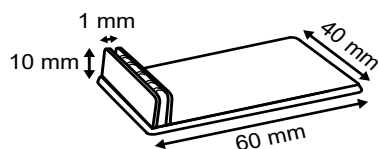

TIC9

Clear polystyrene ticket stand.

L	W	H		☑	🛒
50mm	40mm	9mm	0.5mm	●	

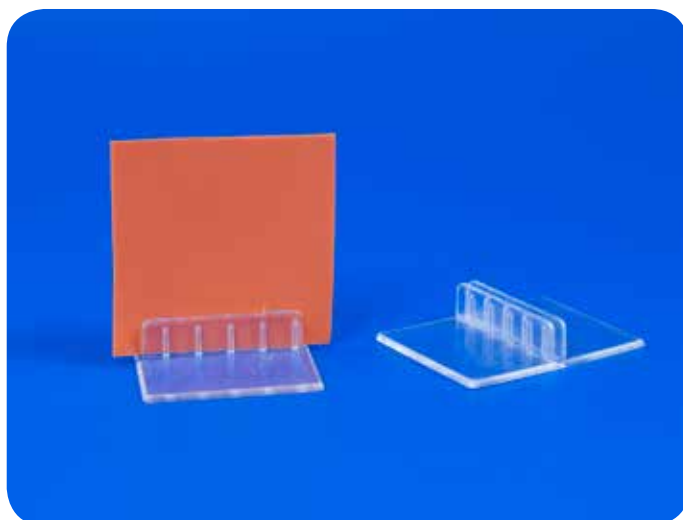
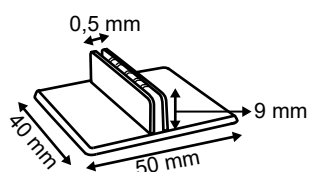

TIC 6

Transparent ice pin with a small ticket holder.

L	W	H	<input checked="" type="checkbox"/>	
150mm	27mm	Max. 0.75mm	●	

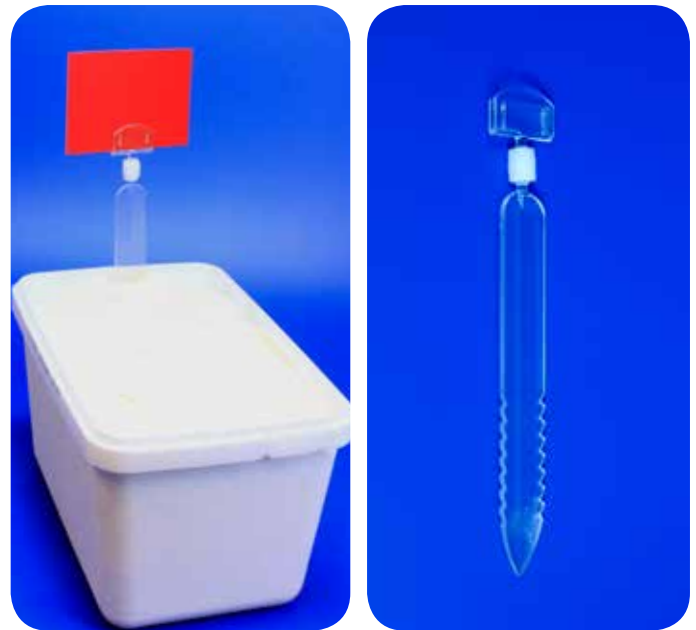
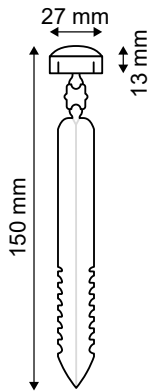

TIC11/V

Stainless steel pin ticket holder (food certificate available).

L	∅	H	<input checked="" type="checkbox"/>	
70mm	15mm	Max. 1mm	●	

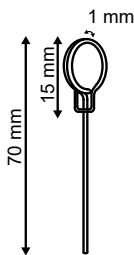

TIC12

White plastic pin ticket holder.

Ticket slides between two lips as shown.

Can be easily interchanged when campaign or special prices.

	TOTAL L	L LIPS	H	<input checked="" type="checkbox"/>	
TIC12/60	103mm	60mm	Max. 1mm	●	
TIC12/80	125mm	80mm	Max. 1mm	●	

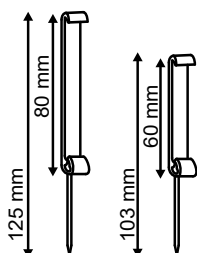

TIC14

Transparent crate clip.

L	W	↔	☑	🛒
140mm	60mm	Max. 10mm	●	

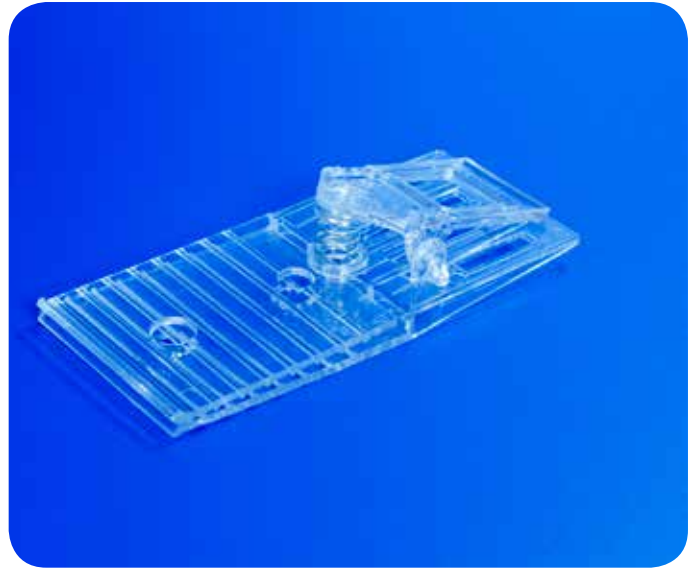
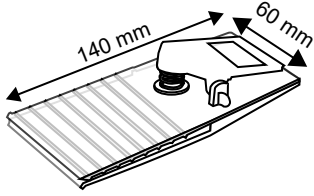

3

TIC23

Media Clip, excellent for holding promotional tickets on kitchenware and similar items. Clips on firmly, will not damage solid items.

H	W	↔ ₁	↔ ₂	☑	🛒
40mm	12mm	0.5mm up to 1.5mm	7.5mm	●	

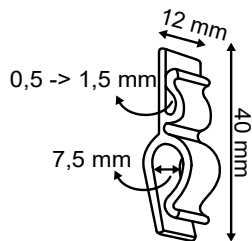

3.11 Polystyrene Ticket Holders

TIC25/100

Clear adjustable polystyrene ticket holder with double clip. This useful ticket holder is easily placed into position and also be moved across a variety of different locations. Very useful as a clip-on to the side of display trays and racks. Small enough that a number of them can be used in a confined area such as display cases or shop windows etc

L	L CLIPS	W CLIPS	↔	☑	🛒
92mm	38mm	20mm	5mm	●	

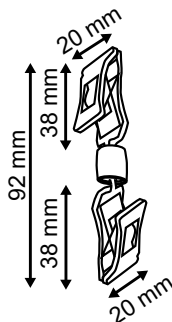

TIC29

Transparent ticket holder with adhesive base and convenient peel-off cover, for easy fixing to most smooth surfaces. The adjustable elbow enables orientations in a variety of positions. The transparent nature of the clip makes it unobtrusive and enables easy reading of the sign it holds.

L	W	∅	↔	☑	🛒
52mm	22mm	22mm	5mm	●	

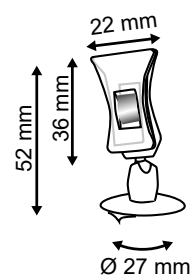

TIC27

Clear polystyrene adjustable ticket holder with a small clip at one end and ticket holder at the other.

L	L CLIP	W CLIP	L HOLDER	H HOLDER	↔	☑	🛒
75mm	37mm	20mm	50mm	13mm / 7mm	Max. 1mm	●	

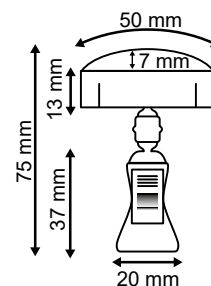

TIC32

Clear magnetic ticket holder for easy fixing to metallic surfaces.

The adjustable elbow enables orientations in a variety of positions.

The transparent nature of the clip makes it unobtrusive and enables easy reading of the sign it holds.

L	L CLIP	W CLIP	∅	┆┆	☑	🛒
69mm	36mm	22mm	20mm	5mm	●	

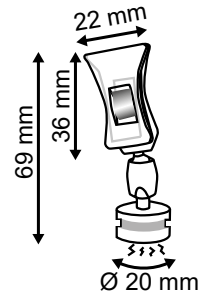

TIC36

Acrylic POS ticket holder with rectangle clip.

This ticket holder has all the benefits of the others with the addition of being able to support a wider display card.

Does also have a curved claw which enables ticket holder to be clamped onto flat and tubular fixtures.

L	L CLIP	W CLIP	L HOLDER	H HOLDER	∅ WIRE	┆┆	☑	🛒
96mm	57mm	22mm	50mm	13mm	15mm	Max. 1mm	●	

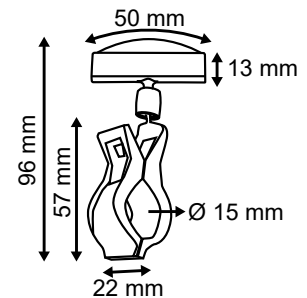
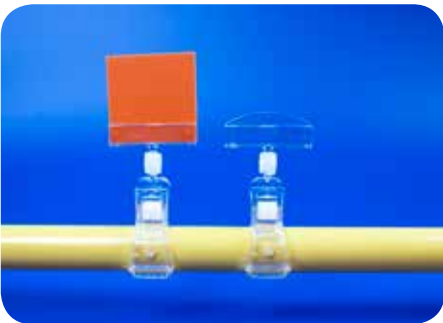

TIC38

Acrylic POS ticket holder with curved clip.

This ticket holder has all the benefits of the others with the addition of being able to support a wider display card.

Does also have a curved claw which enables ticket holder to be clamped onto flat and tubular fixtures.

L	L CLIP	W CLIP	L HOLDER	H HOLDER	∅ WIRE	┆┆	☑	🛒
102mm	57mm	22mm	80mm	20mm	15mm	Max. 2mm	●	

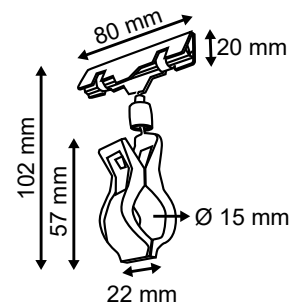

TIC39

Acrylic POS ticket holder with rectangle clip.

This ticket holder has a longer stem between the claw grip and the clip.

Like the previous ones, it supports a wider display card and is orientable.

Has a curved claw which enables ticket holder to be clamped onto flat and tubular fixtures.

L	L CLIP	W CLIP	L HOLDER	H HOLDER	Ø WIRE	┆┆┆	☑	🛒
160mm	57mm	22mm	80mm	20mm	15mm	Max. 2mm	●	

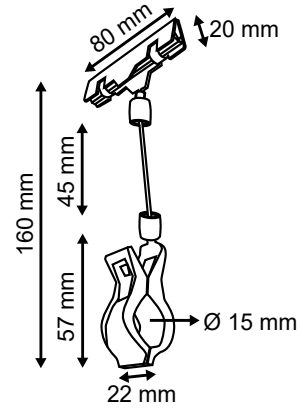
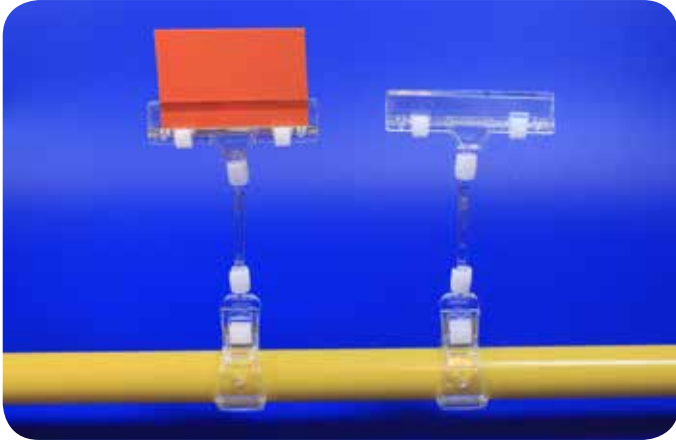

TIC44

Clear transparent self-standing ticket stand.

The actual ticket holder is a curved clip.

Self-assembly.

L	Ø BASE	L HOLDER	H HOLDER	┆┆┆	☑	🛒
90mm	50mm	27mm	17mm	Max. 2mm	●	

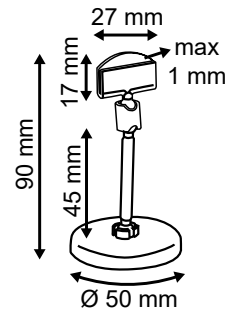

TIC10

Memo clip with clear acrylic base square.

L	BASE	┆┆┆	☑	🛒
110mm	24mm x 24mm	Max. 2mm	●	

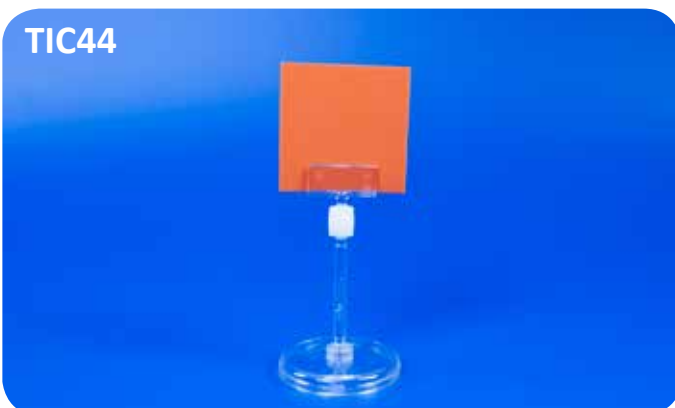
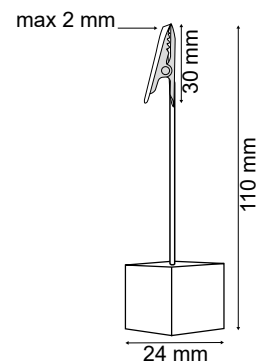

3.12 POS-Clips assembly spare parts

Our POS-Clips product range is made of 30 different individual components. The usage of the different individual parts is normally not as stand-alone products. The different individual components will normally combine and assemble in a myriad of POS Clips.

Find below the product codes and different measurements. All these products can be combined in one way or another. Start from the bottom and simply assemble your choice of base, grippers, magnets, card holders, etc.

Own ticket holder configurations can be built by assembling the different components that match your requirements.

→ All components are made of polystyrene.

	DESCRIPTION	<input checked="" type="checkbox"/>	
TIC50/01	Small gripper	•	
TIC50/02	Large gripper	•	
TIC50/03	Magnet	•	
TIC50/04	Connector	•	
TIC50/05	Stem	•	
TIC50/06	Small ticket holder	•	
TIC50/07	Large gripper	•	



3

TIC50/01

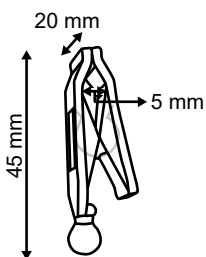

TIC50/02

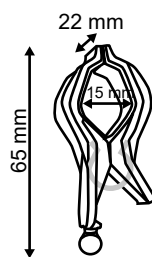

TIC50/03

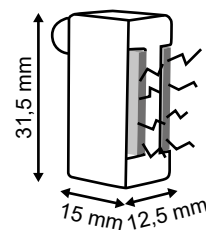

TIC50/04

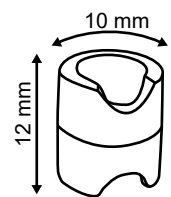

TIC50/05

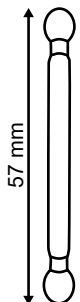

TIC50/06

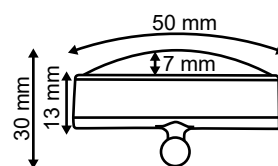

TIC50/07

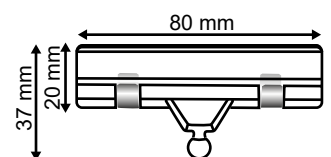

3.13 Suction cups

This range of clear vinyl suction cups can be used to hang point of sale material on windows or walls.



SUC1

Clear PVC suction cup with a holding nipple.

∅	∅ HEAD	↳	☑	🛒
30mm	10mm	6mm	●	

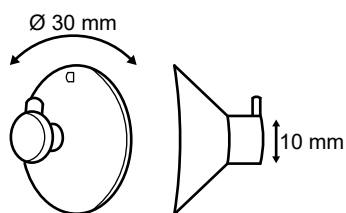

SUC13

Clear vinyl large suction cup with a wider centerpiece.

∅	∅ HEAD	↳	☑	🛒
65mm	17mm	5mm	●	

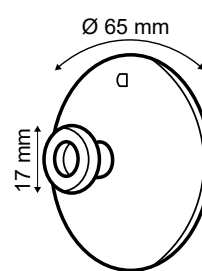

L → length | W → width | H → height | ∅ → diameter | ↳ → capacity | ☑ → stock | 🛒 → on request

SUC2-II

Clear PVC suction cup with a metal hook.

∅	∅ HEAD	<input checked="" type="checkbox"/>	
40mm	14mm	●	

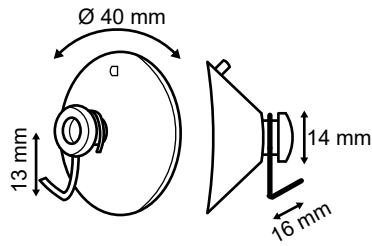

SUC2/ZH

Clear PVC suction cup.

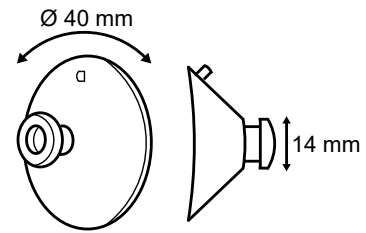

∅	∅ HEAD		<input checked="" type="checkbox"/>	
40mm	14mm	3mm	●	



3

SUC3/P

Clear PVC suction cup with a pin.

∅	∅ PIN		<input checked="" type="checkbox"/>	
43mm	16mm	10mm	●	

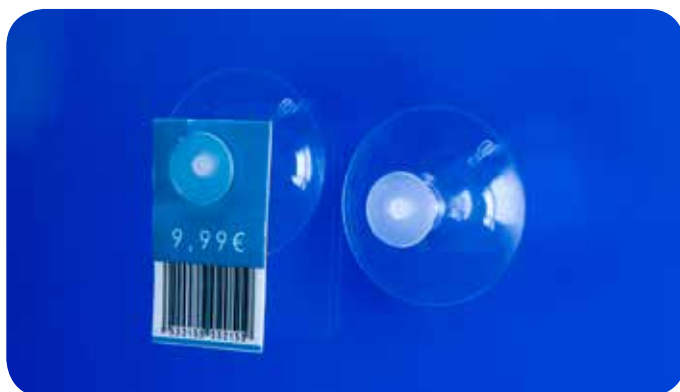
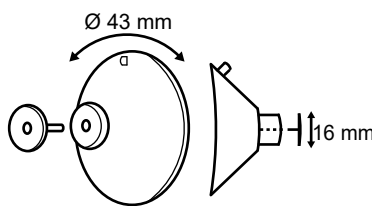

SUC4H

Clear PVC suction cup with a white screw.

∅	∅ SCREW		<input checked="" type="checkbox"/>	
40mm	10mm	4mm	●	

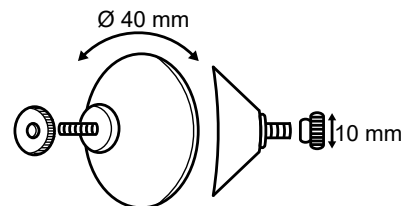

SUC5

UV resistant suction cup with a plastic hook.

∅	∅ HOOK	☑	🛒
36mm	7mm	●	

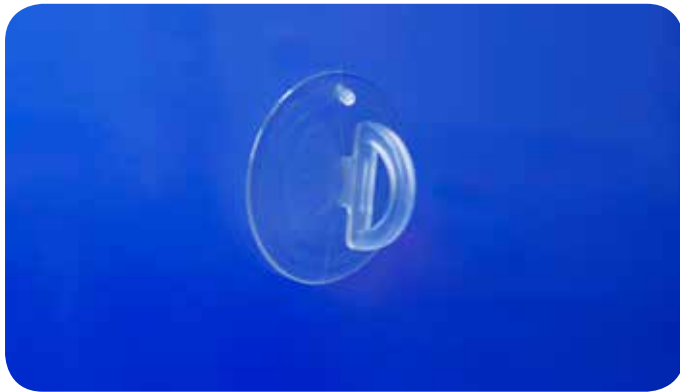
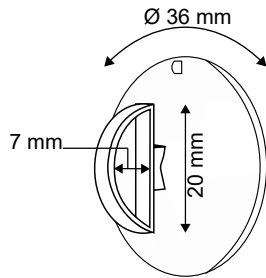

SUC6

Clear PVC double suction cup for extra strong adhesion.

∅	∅ HEAD		☑	🛒
46mm	13mm	4mm	●	

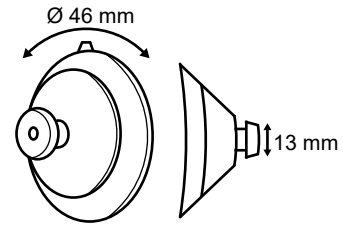

SUC7

Clear PVC double suction cup with a rotating plastic hook.

∅	∅ HEAD	☑	🛒
42mm	14mm	●	

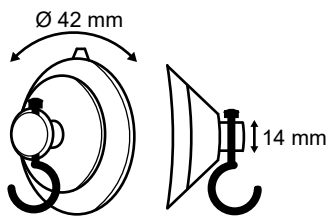

SUC10

Clear PVC suction cup with extra adhesion and a plastic hook.
→ Supplied on request.

∅	L HOOK	W HOOK	☑	🛒
36mm	10mm	8mm	●	

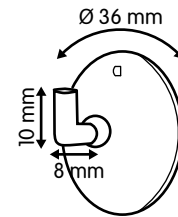

SUC14

Clear PVC suction cup with a poster clip to hang a leaflet.

∅	∅ CLIP	<input checked="" type="checkbox"/>	
30mm	28mm	●	

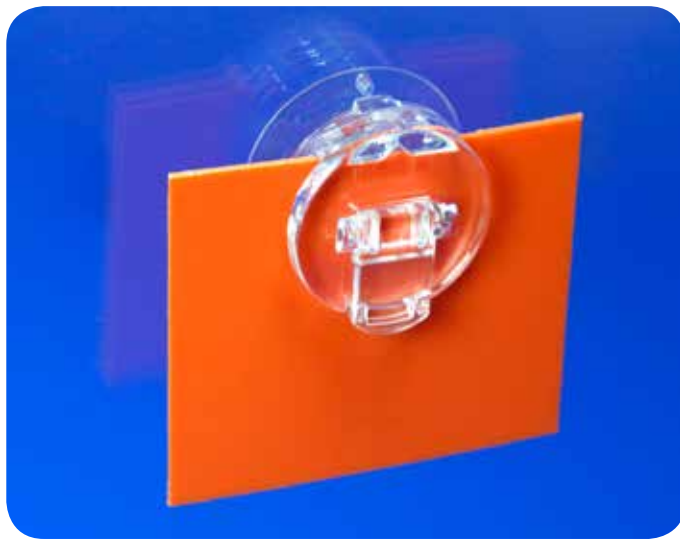
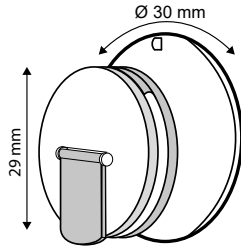

SUC50

Clear PVC double suction cup with a perforation hole for hanging application.

∅	∅ HEAD	∅ EYE	<input checked="" type="checkbox"/>	
45mm	13mm	5mm	●	

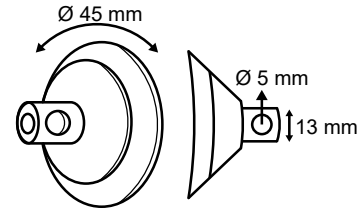

SUC8

Extra strong polypropylene white injection molded suction cup with hook and screw to fix heavy items.

Large suction force is generated by screw when tightened after suction cup is fixed to window.

These suction cups can also be used without the hook.

∅	∅ SCREW	<input checked="" type="checkbox"/>	
60mm	23mm	●	

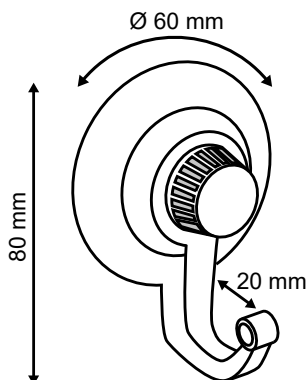

SUC9

Extra strong vinyl suction cup with black hook and large screw to fix heavy items.

∅	∅ HOOK	☑	🛒
65mm	10mm	●	

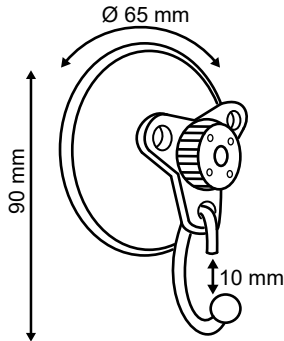

SUC16

Suction cup with metal memo clip.

∅	H CLIP	☑	🛒
36mm	27mm	●	

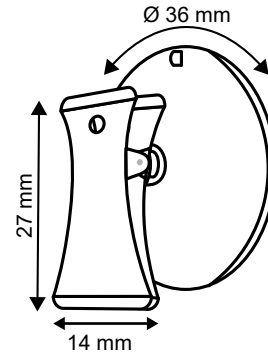

3



Specific & custom request packing

→ We are packing whatever needs to be dispatched.

Please let us know what you need – we will find the appropriate solution. We will take care of the specific packing units you are asking for and pack accordingly. Whether you need products to be packed by 2, 25, 150,... we will do it for you !

→ We can also provide you with fully assembled kits e.g. a ceiling hanger + a metal ceiling hook + a set of poster profiles including its eyelets.

All Round is a true supply partner to its customers and provides real working solutions to their problems. Our objective is to ensure the products will be delivered when you want and in excellent solution. We know on-time delivery is the key component of the order fulfillment process. We ensure the order is accurate and dispatched with proper packing & labelling.



3.14 Badge holders

PVC badge holders incorporating attachment options for lanyards, pins and adhesive uses include ID, reception visitor badges and exhibition ID cards.



3

BAD1

Adhesive badge clip with safety pin

L	W	PIN	<input checked="" type="checkbox"/>	
24mm	14mm	32mm	●	

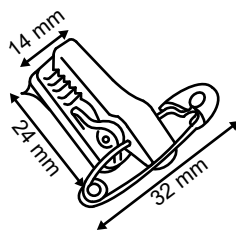

BAD5

White plastic adhesive badge pin.

L	W	COLOR	<input checked="" type="checkbox"/>	
36/38mm	8mm	white	●	

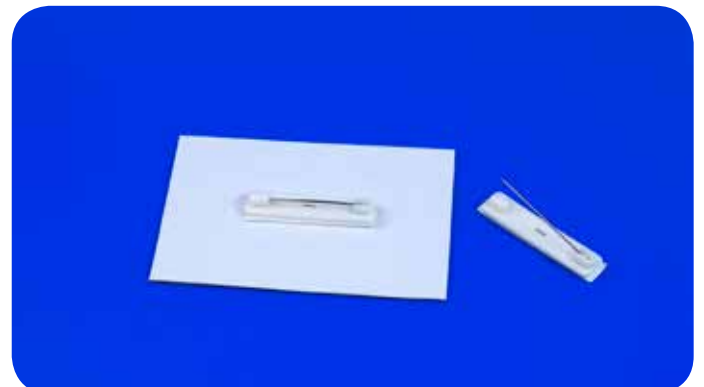

BAD8

Metal adhesive badge clip.

L	W	Ø EYE	FIXATION	<input checked="" type="checkbox"/>	
23mm	19mm	5mm	Adhesive	•	

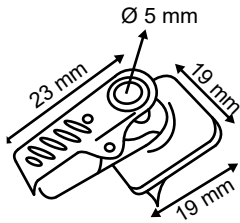

MAG8

Rectangular adhesive magnet for badge.

L	W	<input checked="" type="checkbox"/>	
45mm	13mm	•	

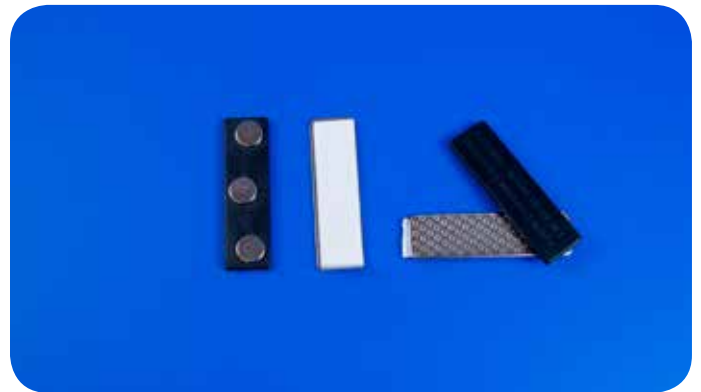
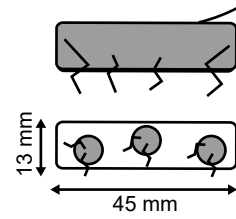

MAG8/R

Round adhesive magnet for badge.

Ø	<input checked="" type="checkbox"/>	
17mm	•	

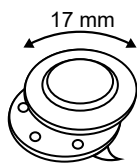

CLI17

Metal clip with suspension eyelet, for cords or lanyards.

L	W	Ø EYE	<input checked="" type="checkbox"/>	
27mm	10mm	5mm	•	

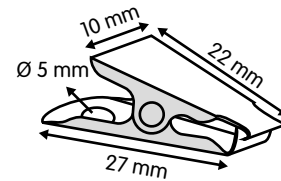

BAD33

Metal badge clip with transparent attachment loop.

L	W	L CLIP	W CLIP	☑	🛒
55mm	12mm	23mm	10mm	●	

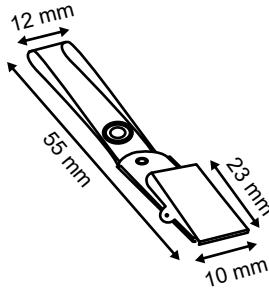

BAD16

Clear stiff PVC badge holder with oval suspension eyelet. Clip is not provided, must be purchased separately.

L	W	☑	🛒
94mm	54mm	●	

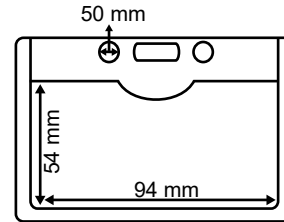

BAD26

Clear rigid PVC badge holder with a "Euroslot" eyelet.

L	W	☑	🛒
86mm	55mm	●	

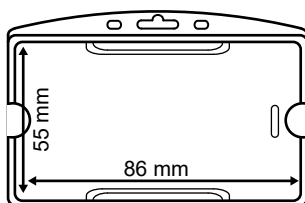

BAD54

Extendable cable fixed to a round clip.
Is used to attach security passes, ID's, visitor badges etc.
→ Cable length 850mm

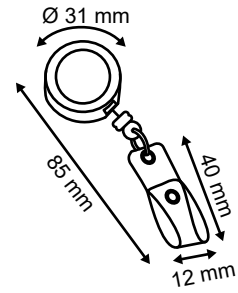

	L	W	Ø CLIP	COLOR	☑	🛒
BAD54/G	85mm	12mm	31mm	Grey	•	
BAD54/TB	85mm	12mm	31mm	Transparent Blue		•
BAD54/W	85mm	12mm	31mm	White		•



BAD12

Clear plastic badge holder with a clip and safety pin on the backside.

	L	W	☑	🛒
BAD12	90mm	57mm	•	

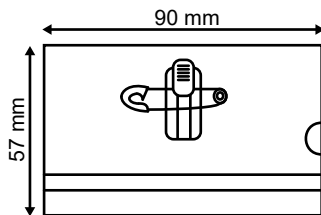

MAG9

Clear plastic badge holder with a strong magnet on the backside.

	L	W	☑	🛒
MAG9	75mm	47mm	•	

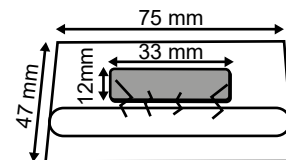

4. Leaflet dispensers

Often your clients need more information than only technical details and a price. In this case, you like to offer them a folder, a product file or a business card, neatly arranged in a brochure holder or a card support. The support pieces come in plastic as well as in cardboard and we deliver them as separate parts or fully mounted. The benefits? Your campaign immediately attracts the attention and you can change the content whenever you want.

Looking for personalized brochure holders? Please give us a sign and you will get all possible options. No strings attached.

4.1 Leaflet dispensers

4.2 Brochure stands

4.3 Business card holders

4.4 Card boxes

4.5 Calendar boxes

4.6 Leaflet holders

4.7 Cardboard display stand

4.8 Adhesive pockets

4.9 Non-adhesive pockets

4.1 Leaflet dispensers

Acrylic Displays, leaflet dispensers and brochure holders are a cost effective and high impact solution for all presentation of your folders, entry forms, business cards, promotional messages, samples, etc. The range also includes all types of sign and menu display units.

LEA3H

Clear PVC leaflet dispenser with round corners, adhesive tape and 2 hanging holes.

	SIZE	ADHESIVE	<input checked="" type="checkbox"/>	
LEA3H/12	1/3 A4 Portrait	Permanent	•	
LEA3H/13	A5 Landscape	Permanent	•	
LEA3H/14	A6 Landscape	Permanent	•	
LEA3H/18	A6 Portrait	Permanent	•	

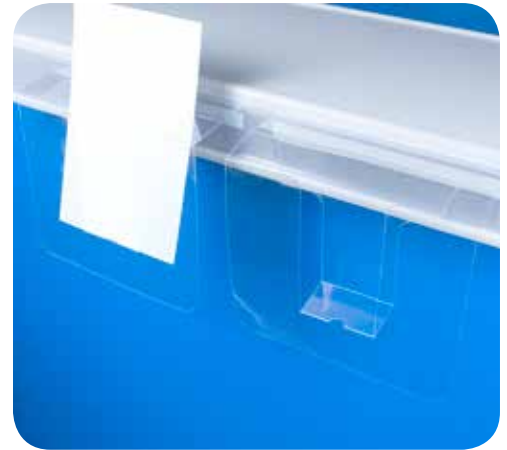

4

LEA4/N - LEA5/N - LEA6/N

Clear polystyrene counter or wall leaflet dispenser with 1 hanging hole.

	SIZE	⇄	<input checked="" type="checkbox"/>	
LEA4/N	A4	Max.75mm	•	
LEA5/N	A5	Max.55mm	•	
LEA6/N	A6	Max.55mm	•	



LEA6/NB

Clear polystyrene counter leaflet dispenser in size 1/3 A4.

	SIZE	⇄	<input checked="" type="checkbox"/>	
LEA6/NB	1/3 A4	Max.45mm	•	

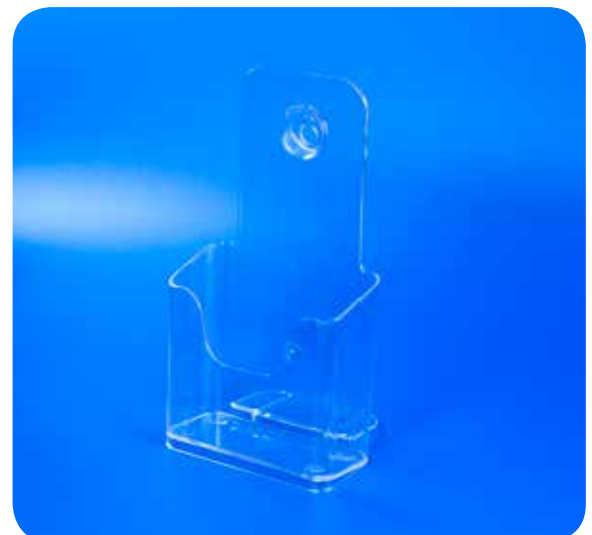

LEA4X3/N - LEA5X4/N - LEA6X4/N

Clear polystyrene counter or wall multi pocket leaflet dispenser.

	SIZE	⇄	☑	🛒
LEA4X3/N	A4	3XA4	•	
LEA5X4/N	A5	4XA5	•	
LEA6X4/N	A6	4XA6	•	



LEA14

Clear polystyrene wall mounted leaflet dispenser with 2 hanging holes.

	SIZE	⇄	☑	🛒
LEA14/A4	A4	Max.36mm	•	
LEA14/A5	A5	Max.36mm	•	
LEA14/A6	A6	Max.52mm	•	

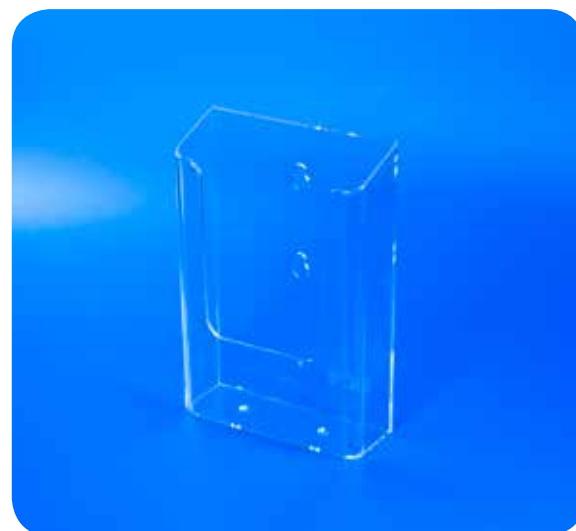

To be combined with



LEA14/SLAT

Clear polystyrene slat wall clip for wall mounted leaflet dispenser.

	L	W	H	⇄	☑	🛒
LEA14/SLAT	50mm	7mm	10mm	8mm	•	

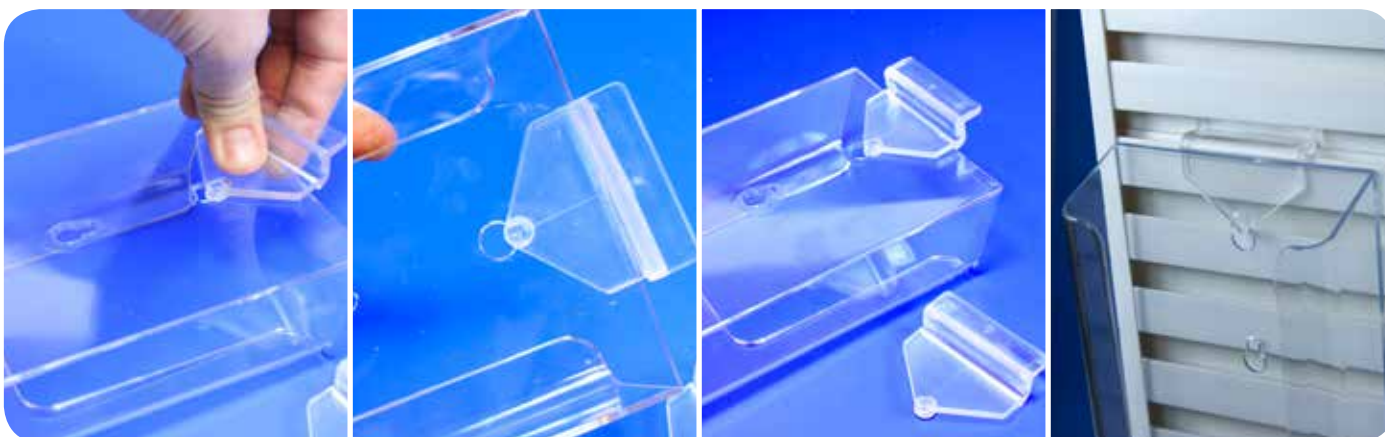

4.2 Brochure stands

KAD13/A4

Vertical or horizontal decorative brochure stand in polycarbonate.

	SIZE	TOTAL HEIGHT	↔	☑	🛒
KAD13/A4V	A4 Portrait	1000mm	Max.30mm	•	
KAD13/A4H	A4 Landscape	1000mm	Max.100mm	•	



BRO2

Foldable brochure holder set in aluminum and acrylic. This foldable brochure stand is a very practical and easy solution, for temporary events / venues. Transportation bag included.

	SIZE	↔	☑	🛒
BRO2	A4	5XA4	•	



L → length | W → width | H → height | Ø → diameter | ↔ → capacity | ☑ → stock | 🛒 → on request

4.3 Business card holders

LEA12

Transparent polystyrene business card holder with 8 compartments.

L	W	H	⇄	☑	🛒
200mm	95mm	98mm	Max.23mm	●	



LEA13/N

Transparent polystyrene business card holder.

L	H	⇄	☑	🛒
110mm	55mm	Max.22mm	●	



LEA13/RVS

Stainless steel business card holder.

L	W	H	⇄	☑	🛒
90mm	50mm	45mm	Max.25mm	●	

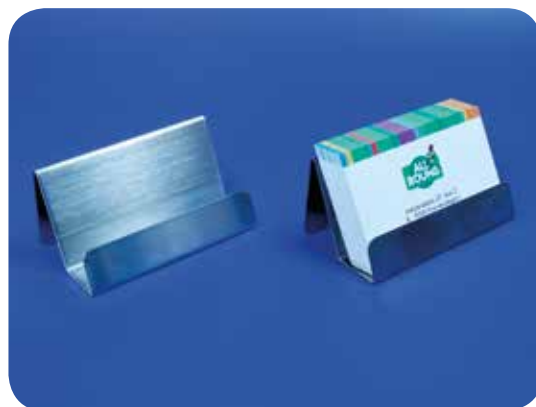

LEA17

Clear polystyrene horizontal or vertical counter business card holder.

	SIZE	☑	🛒
LEA17/A5H	A5 Landscape	●	
LEA17/A6H	A6 Landscape	●	
LEA17/A6	A6 Portrait	●	



4.4 Card boxes

LEA13/G

Transparent polystyrene business card box.

	L	W	H	⇄	☑	🛒
LEA13/G	90mm	37mm	35mm	Max.26mm	●	



LEA40/T

Clear plastic small business card box.

	L	W	☑	🛒
LEA40/T	90mm	56mm	●	



4.5 Calendar boxes

CDB

Clear polystyrene calendar box.

	H	W	☑	🛒
CDB1	141mm	126mm	●	
CDB2	98mm	96mm	●	



L → length | W → width | H → height | Ø → diameter | ⇄ → capacity | ☑ → stock | 🛒 → on request

4.6 Leaflet holders

LEA9

Clear acrylic double-sided leaflet holder, with double folded foot.

→ Printing supplied on request.

	SIZE	THICKNESS	✓	🛒
LEA9/A3	A3	3mm	•	
LEA9/A4	A4	2mm	•	
LEA9/A5	A5	2mm	•	
LEA9/A6	A6	2mm	•	
LEA9/13A4	1/3 A4	2mm	•	



LEA10

Clear acrylic single-sided leaflet holder.

→ Printing supplied on request.

	SIZE	THICKNESS	✓	🛒
LEA10/A3	A3	3mm	•	
LEA10/A4	A4	2mm	•	
LEA10/A5	A5	2mm	•	
LEA10/A6	A6	2mm	•	
LEA10/13A4	1/3 A4	2mm	•	



LEA8

Clear PVC menu holder for counter standing.

	⇄	✓	🛒
LEA8/A4	A4	•	
LEA8/A5	A5	•	
LEA8/A6	A6	•	

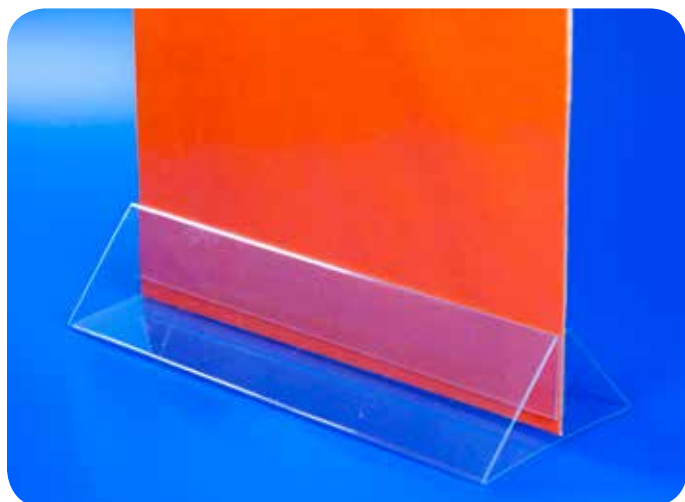

LEA18

Clear plastic double-sided leaflet holder with base.

→ Delivered not assembled.

	SIZE	✓	🛒
LEA18/A4	A4	•	
LEA18/A6	A6	•	



LEA10/PET - LEA10/PS

Clear single-sided leaflet holder in PET or PS.

→ Only supplied on request with or without printing.

	SIZE	THICKNESS	MATERIAL	<input checked="" type="checkbox"/>	
LEA10/A4PET	A4	1.5mm	PET	<input type="checkbox"/>	•
LEA10/A4PS	A4	1.5mm	PS	<input type="checkbox"/>	•
LEA10/A5PET	A5	1mm	PET	<input type="checkbox"/>	•

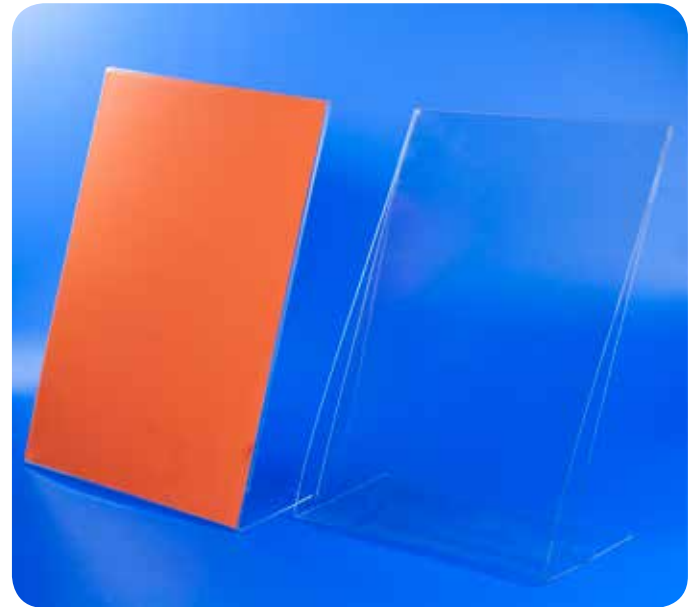
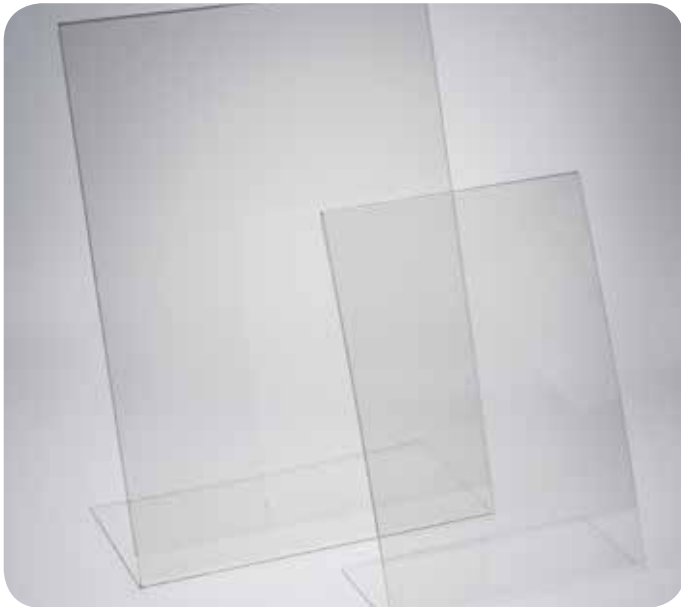

LEA2

White curved shaped standing leaflet holder with an anti-reflex cover.

	SIZE	<input checked="" type="checkbox"/>	
LEA2/A4	A4	•	
LEA2/A5	A5	•	

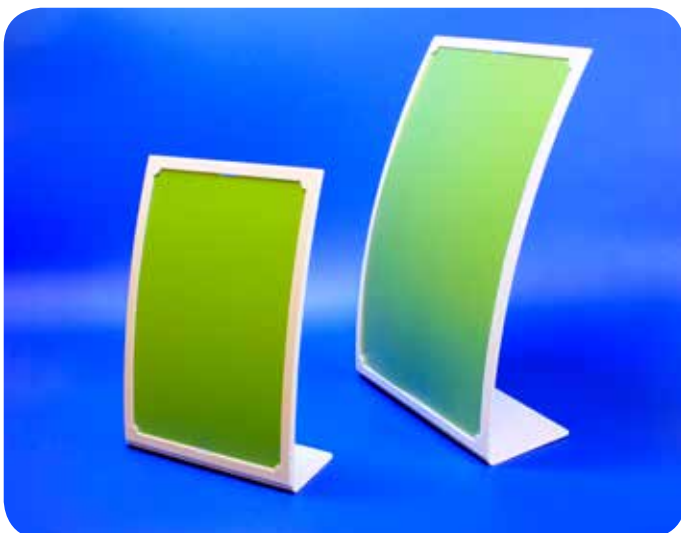

LEA11

Clear acrylic vertical counter leaflet holder.

	SIZE	THICKNESS	<input checked="" type="checkbox"/>	
LEA11/A4	A4	3mm	•	
LEA11/A5	A5	2mm	•	
LEA11/13A4	1/3 A4	2mm	•	



LEA23

Clear PVC leaflet holder. This leaflet holder has the advantage of being delivered flat, which is easy and saves shipping & packing costs. It is also supplied in separate cello bags, to prevent the leaflet holder from being scratched at any time.

	SIZE	<input checked="" type="checkbox"/>	
LEA23/A4	A4	•	
LEA23/A5	A5	•	

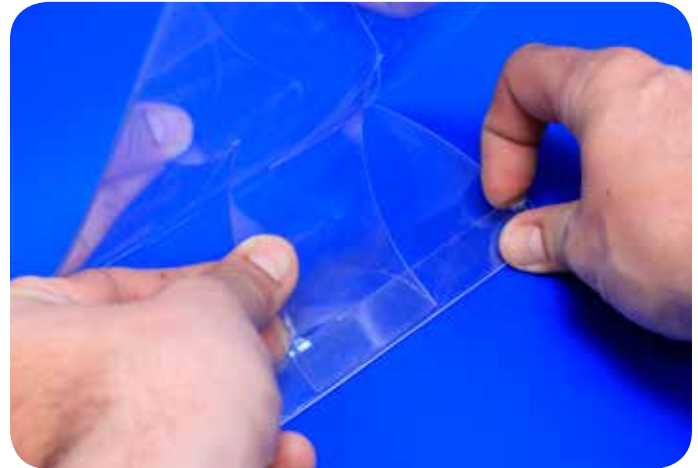
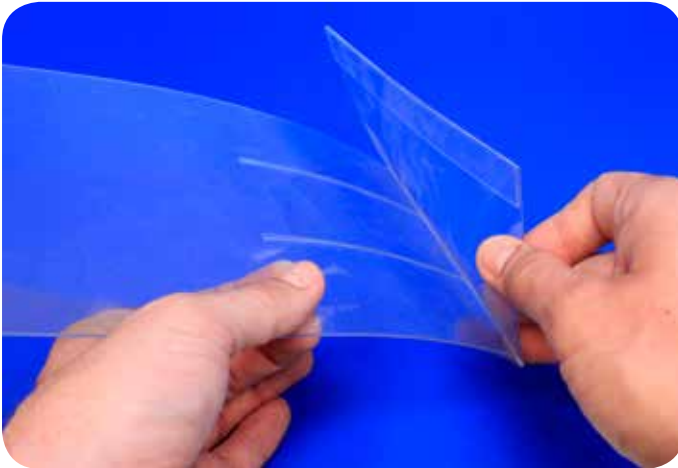
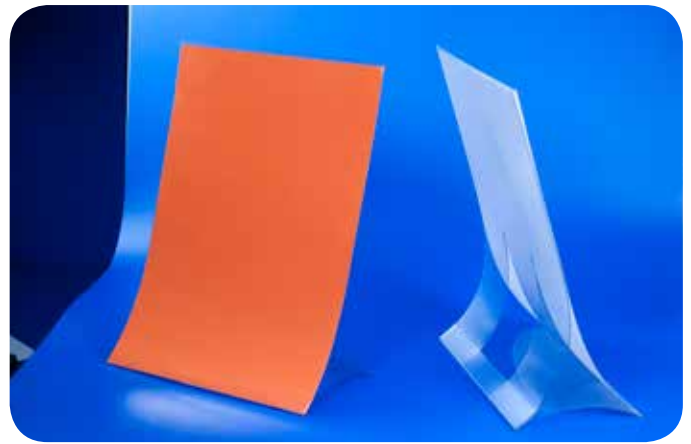

4

MEN21

Clear acrylic sign holder with a small leaflet dispenser on the front side.

	SIZE HOLDER	SIZE LEAFLET	<input checked="" type="checkbox"/>	
MEN21/A4/1/3/A4	A4	1/3 A4	•	
MEN21/A4/A5	A4	A5	•	

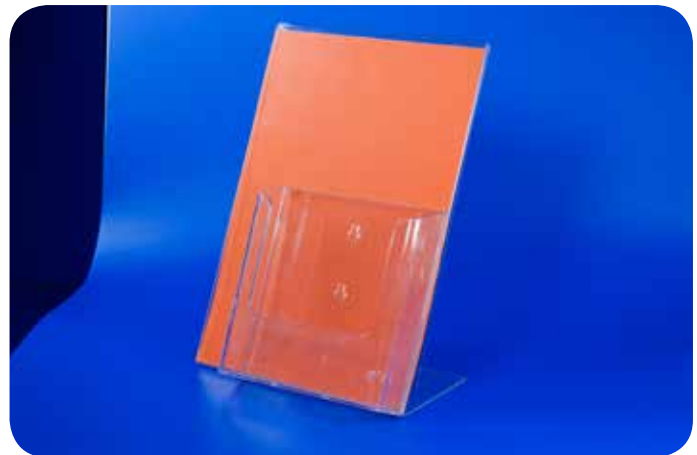



PLO/...

Clear PVC wall mounted leaflet holder with 2 hanging holes on top. The bottom is closed. This leaflet holder can be supplied in recyclable PET-material on request.

	SIZE	Ø HOLE	<input checked="" type="checkbox"/>	
PLO/A3	A3	5mm	•	
PLO/A4	A4	5mm	•	
PLO/A5	A5	5mm	•	
PLO/A6	A6	5mm		•



L → length | W → width | H → height | Ø → diameter |  → capacity | → stock |  → on request

LEA1

Clear acrylic counter mounted leaflet holder with 2 space holders.

	SIZE	USE	<input checked="" type="checkbox"/>	
LEA1/A4	A4	Counter	•	
LEA1/A6	A6	Counter	•	



LEA1/W

Clear acrylic wall mounted leaflet holder with 4 space holders.

	SIZE	USE	<input checked="" type="checkbox"/>	
LEA1/W	A4	Wall	•	



LEA35

Magnetic acrylic block with a total thickness of 30mm. Its premium look will stand out for messages on luxury products.

	SIZE	THICKNESS	<input checked="" type="checkbox"/>	
LEA35/A4	A4	2X15mm	•	
LEA35/A5	A5	2x15mm	•	
LEA35/A6	A6	2x15mm	•	

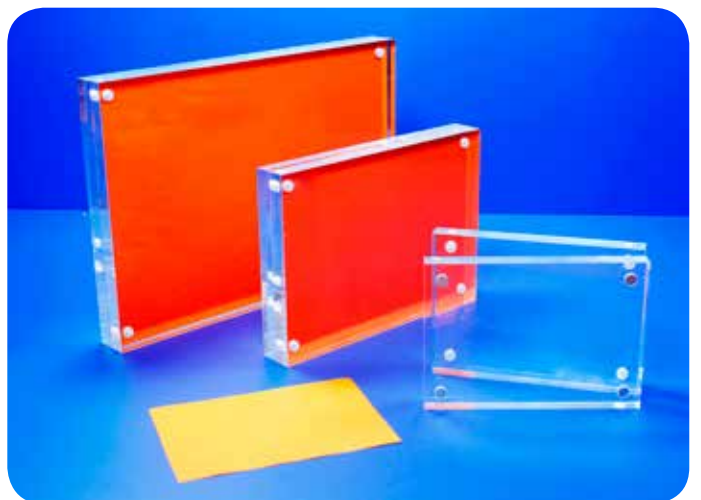
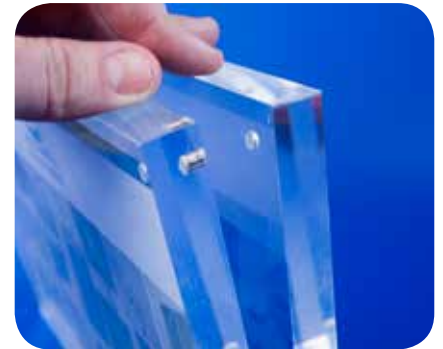

L → length | W → width | H → height | Ø → diameter |  → capacity | → stock |  → on request

Acrylic on request

Besides our standard stock items we are also able to offer custom made clear styrene leaflet dispensers, sign holders, display cases, phone holders and so much more... any shape, any design is possible.



4

*We are just a phone call away.
+32 (0)9 363 93 60*

4.7 Cardboard display stand

BAC1/MT

Cardboard display stand with adhesive tape on the back.

- Cardboard back supports are produced from a sturdy cardboard case and are delivered flat (or for when the sign is not in use).
- The unique press-out brace gives the support a sturdiness that is not found in other braces of this type. Various sizes are available as a stock line and can be fitted to A4, A5 and even A3 sizes, ...
- The adhesive strip provides a secure long lasting hold on the back support and can be attached to paper, card, polypropylene, corflute, aluminium and so many other surfaces.
- The support is also fitted with a special tab should there be a need to hang the sign.
- The **EASY PEEL** feature enables a quick and rapid manual removing of the backing paper

	H	EASY PEEL	<input checked="" type="checkbox"/>	
BAC1/MT100°	100mm	•	•	
BAC1/MT150°	150mm	•	•	
BAC1/MT200°	200mm	•	•	
BAC1/MT250°	250mm	•	•	
BAC1/MT300°	300mm	•	•	
BAC1/MT350°	350mm	•	•	
BAC1/MT400	400mm		•	
BAC1/MT500	500mm		•	
BAC1/MT710	710mm		•	

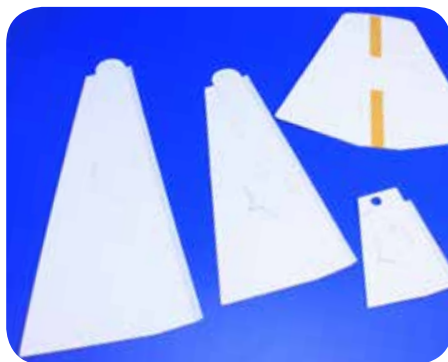

BAC2/MT190

Double cardboard display stand with adhesive tape on the back.
Can be used for size A4 or A5.

	H	SIZE	<input checked="" type="checkbox"/>	
BAC2/MT190	187mm	A4 / A5	•	



4.8 Adhesive pockets

POC1/RH

Clear polypropylene adhesive pocket with short edge open.

	SIZE	<input checked="" type="checkbox"/>	
POC1/RHA3	A3	•	
POC1/RHA4	A4	•	
POC1/RHA5	A5	•	
POC1/RHA6	A6	•	
POC1/RHA7	A7	•	



4

DRH

Clear PVC adhesive corners.

	SIZE	<input checked="" type="checkbox"/>	
DRH3	30 x 30mm	•	
DRH5	50 x 50mm	•	
DRH7.5	70 x 70mm	•	
DRH10	100 x 100mm	•	
DRH12	120 x 120mm	•	
DRH14	140 x 140mm	•	
DRH17	170 x 170mm	•	
DRH20	200 x 200mm	•	



BAD15

Clear polypropylene adhesive badge pocket with thumb recess.

	L	W	<input checked="" type="checkbox"/>	
BAD15	93mm	56mm	•	



4.9 Non-adhesive pockets

BAD20/././S

Clear soft-PVC display pocket with hanging hole.
With metal ring supplied on request (BAD20/././MR).

	SIZE	∅ HANGING HOLE	<input checked="" type="checkbox"/>	
BAD20/A4/S	A4	5mm	•	
BAD20/A5/S	A5	5mm	•	
BAD20/A6/S	A6	5mm	•	
BAD20/A7/S	A7	5mm	•	

POCES

Clear electrostatic pocket. Can be attached to the window without adhesive.

	SIZE	<input checked="" type="checkbox"/>	
POCES/A8	A8		•
POCES/A7	A7		•
POCES/A6	A6	•	
POCES/A5	A5	•	
POCES/A4	A4	•	
POCES/A3	A3	•	
POCES/A2	A2		•
POCES/A1	A1		•

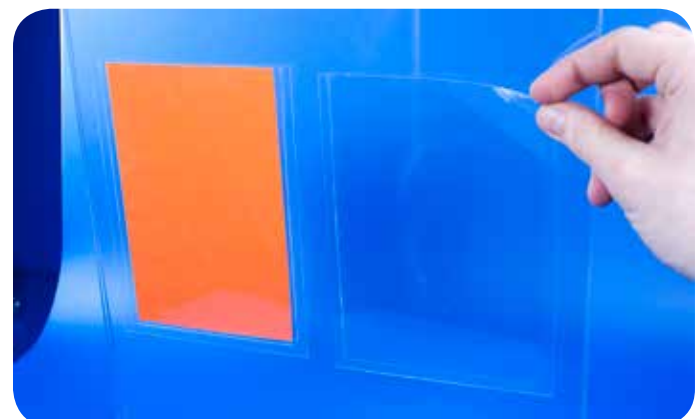

5. Display Accessories

Several products are ideal to be presented packed and displayed on merchandising hooks, mounted in different ways on the wall. The benefits? You save space, maintain the overview and the client can help himself easily.

You make a selection of different materials and mounting systems, depending on your product. Next, you finish as you wish with limiting clips, label holders and anti-theft systems.

Your product hasn't got a hole yet in order to hang it up? Then our unique adhesive Hang Tabs are made for you. Cheaper than blister packages, incredibly easy to use and moreover made of fully recyclable material.

Other accessories within this range are rotating displays and protection and connection pieces for normal displays.

You want some extra effect? Then quickly move on and also discover our LED lights.

- 5.1 Pegboard plastic prongs
- 5.2 Cardboard plastic prongs
- 5.3 Adhesive plastic prong
- 5.4 Universal plastic prongs
- 5.5 Double-sided plastic prongs
- 5.6 Pegboard metal prongs
- 5.7 Stock limiters for prongs
- 5.8 Label holders for prongs
- 5.9 Anti-theft systems for prongs
- 5.10 Hang Tabs
- 5.11 Turn tables
- 5.12 Cardboard tube accessories
- 5.13 Display feet accessories
- 5.14 Display assembly accessories
- 5.15 LED display accessories

5.1 Pegboard plastic prongs

Injection moulded plastic pegboard hooks with single or double prong are suitable for standard pegboards.

PEG1

Double prong in white plastic with 2 arms and a small price holder for pegboard displays.

→ Custom colors or lengths supplied on request.

	L	W	<input checked="" type="checkbox"/>	
PEG1/50	50mm	25mm	●	
PEG1/100	100mm	25mm	●	
PEG1/200	200mm	25mm	●	

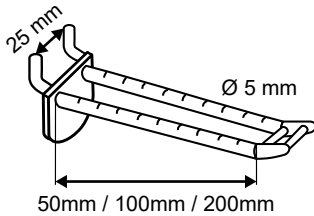

PEG2 - PEG3 - PEG4 - PEG5

Single prong in white plastic with 2 arms for pegboard displays.

→ Custom colors or lengths supplied on request.

	L	W	<input checked="" type="checkbox"/>	
PEG2	50mm	25mm	●	
PEG3	100mm	25mm	●	
PEG4	150mm	25mm	●	
PEG5	200mm	25mm	●	

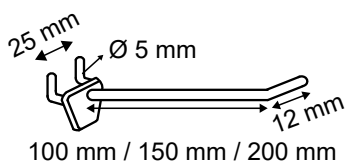
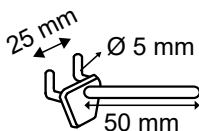

PEG6/50 - PEG6 - PEG7 - PEG8

Double prong in white plastic with 2 arms for pegboard displays.

→ Custom colors or lengths supplied on request.

	L	W	☑	🛒
PEG6/50	50mm	25mm	●	
PEG6	100mm	25mm	●	
PEG7	150mm	25mm	●	
PEG8	200mm	25mm	●	

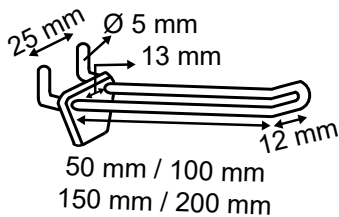

Free (*) Samples !

You have decided to purchase a product from our range. However you still hesitate if it's the right product for your display and whether it will suit your needs....

In this case we can send you some free samples for you to carry out a relevant test.

→ Any samples will be sent to you for free, provided their gross value do not exceed (*) 5,- € (inclusive of VAT)).



Any samples requests are welcome at

info@all-round.be

5.2 Cardboard plastic prongs

Single or double prongs, self-piercing merchandising hooks with 3 spikes can be easily used on corrugated cardboard displays or corflute.

PRO1/././3

Single prong in white plastic with 3 spikes for cardboard displays.

→ Custom colors or lengths supplied on request.

	L	W	<input checked="" type="checkbox"/>	
PRO1/50/3	50mm	25mm	●	
PRO1/100/3	100mm	25mm	●	
PRO1/150/3	150mm	25mm	●	
PRO1/200/3	200mm	25mm	●	

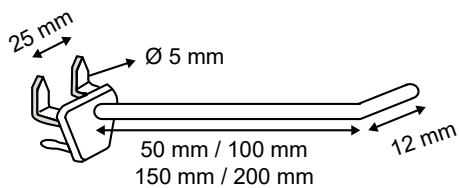

PRO2

Strong automatic hook prong in white plastic for cardboard displays.

PRONG L	W	H	∅	<input checked="" type="checkbox"/>	
34mm	26mm	25mm	15mm	●	

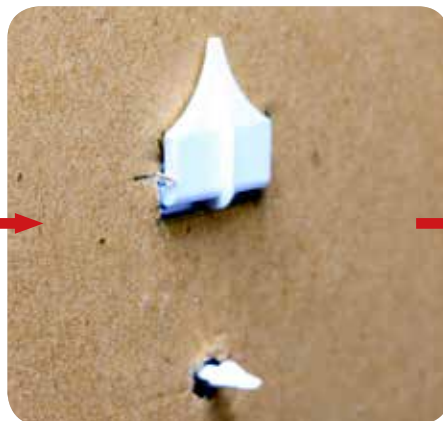
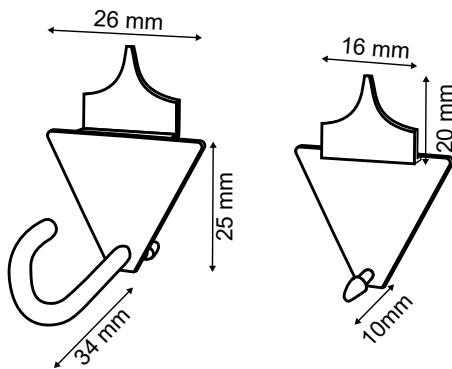

L → length | W → width | H → height | ∅ → diameter |  → capacity | → stock |  → on request

PRO3/././3

Double prong in white plastic with 3 spikes for cardboard displays.

→ Custom colors or lengths supplied on request.

	L	W	<input checked="" type="checkbox"/>	
PRO3/100/3	100mm	25mm	●	
PRO3/150/3	150mm	25mm	●	
PRO3/200/3	200mm	25mm	●	

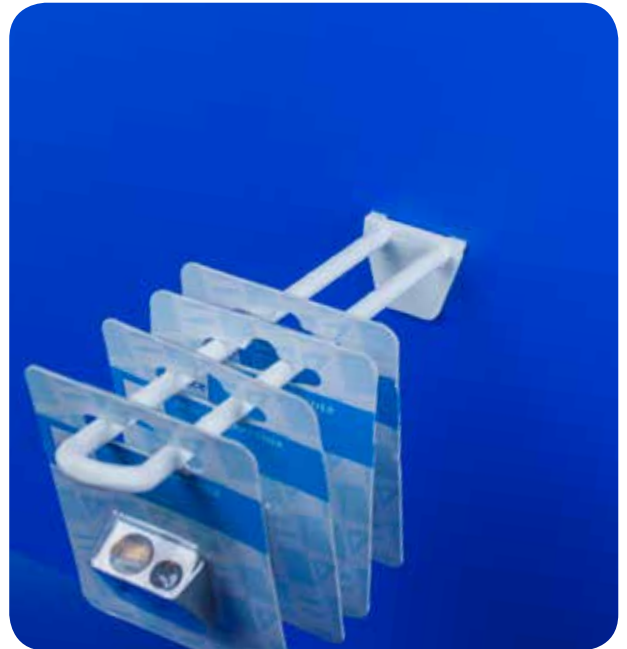
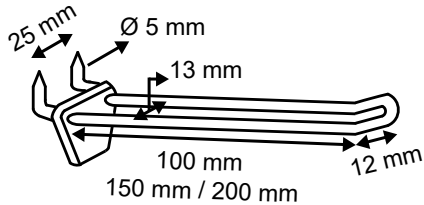

PRO4

Double prong in white plastic with 3 spikes and a small price holder for cardboard displays.

→ Custom colors or lengths supplied on request.

	L	W	BACK H	<input checked="" type="checkbox"/>	
PRO4/50	50mm	25mm	10mm	●	
PRO4/100	100mm	25mm	10mm	●	
PRO4/150	150mm	25mm	10mm	●	

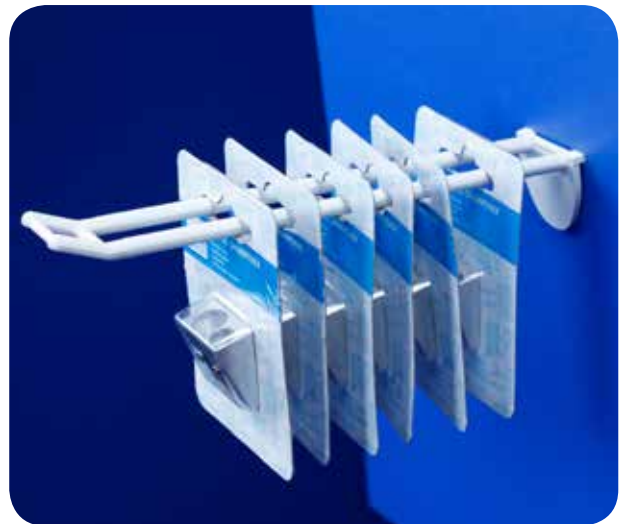
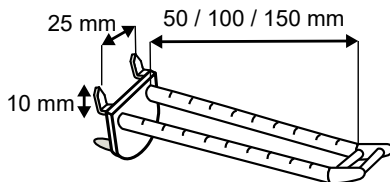

5

5.3 Adhesive plastic prong

Self-adhesive prongs are a simple and practical way recommended to hang lightweight items.

PEG9/60

Single adhesive prong in white plastic.

L	W	BACK H	<input checked="" type="checkbox"/>	
60mm	26mm	28mm	●	

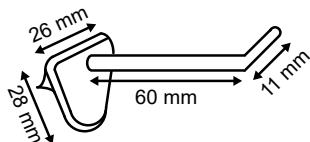

5.4 Universal plastic prongs

Universal plastic prongs are an ideal way to fit over edges or being inserted into precut slots for a neat finish of your displays.

PEG11

Single universal prong in white plastic.

The prong can be used on top of a display or in a cardboard hole.

→ Custom colors or lengths supplied on request.

	L	W	BACK H	<input checked="" type="checkbox"/>	
PEG11/50	50mm	19mm	32mm	<input type="checkbox"/>	•
PEG11/100	100mm	19mm	32mm	•	
PEG11/150	150mm	19mm	32mm	•	

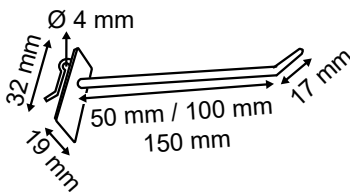

PEG12P

Wide universal "Euro-Lock" prong with fixed label holder in white plastic.

The prong can be used on top of a display or in a cardboard hole.

→ Custom colors or lengths supplied on request.

→ Label Holder: 34mm high X 50mm wide.

	L	BACK W	BACK H	<input checked="" type="checkbox"/>	
PEG12P/70	70mm	30mm	50mm	•	
PEG12P/120	120mm	30mm	50mm	•	
PEG12P/150	150mm	30mm	50mm	•	
PEG12P/170	170mm	30mm	50mm	•	

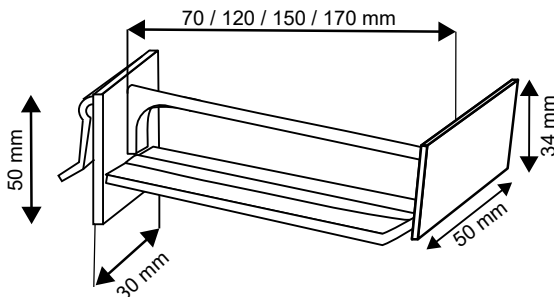

PEG12

Wide universal "Euro-Lock" prong in white plastic. The prong can be used on top of a display or in a cardboard hole.

→ Custom colors or lengths supplied on request.

	L	W	H	<input checked="" type="checkbox"/>	
PEG12/70	70mm	19mm	39mm	•	
PEG12/120	120mm	19mm	39mm	•	
PEG12/150	150mm	19mm	39mm	•	
PEG12/170	170mm	19mm	39mm	•	
PEG12/250	250mm	19mm	39mm		•

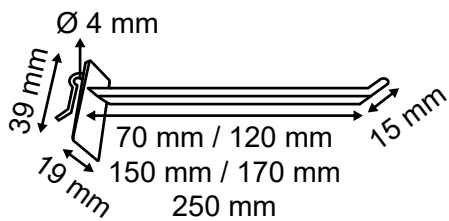

BAN4/V - BAN4/H

Magnetic banner holder that can be used in vertical or horizontal way.

→ Only supplied on request.

	L	BAN FIXATION	<input checked="" type="checkbox"/>	
BAN4/V	110mm	Magnet		•
BAN4/H	110mm	Magnet		•



BAN4/V

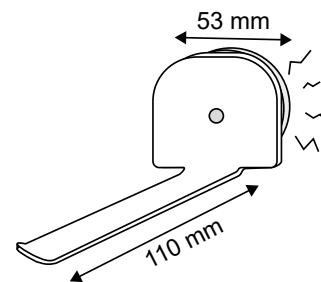

BAN4/H

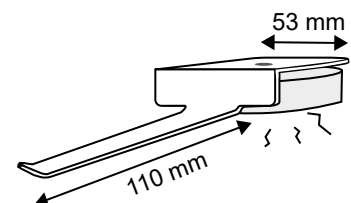

5.5 Double-sided plastic prongs

The double-sided plastic prongs are suitable to display blistered items or samples on both sides.

PEG12D

Wide double-sided "Euro-Lock" prong in white plastic.

	L	W	<input checked="" type="checkbox"/>	
PEG12D/50	50mm	19mm	●	
PEG12D/100	100mm	19mm	●	
PEG12D/120	120mm	19mm	●	
PEG12D/150	150mm	19mm	●	

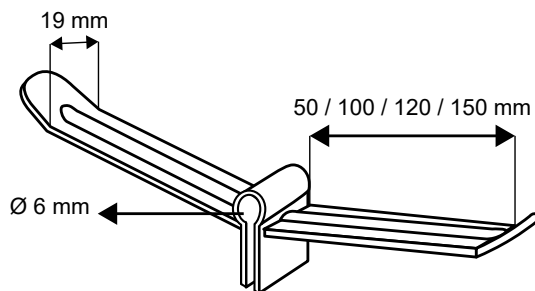
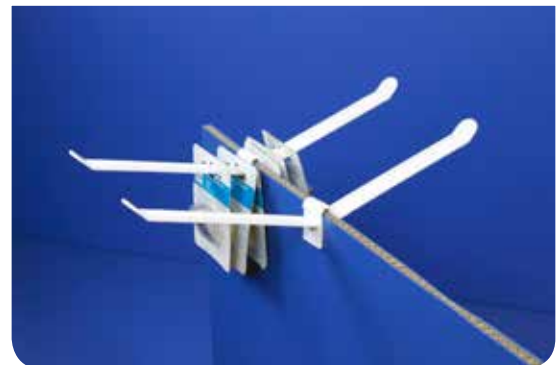

Standard & Specific Sizes

Besides our standard stock items, you may need a custom made PVC pocket or a specific acrylic display dimension. We can then manufacture the exact requested size upon request for you. Please find below the commonly used standard dimensions:

- A1: 841mm H X 594mm W
- A2: 594mm H X 420mm W
- A3: 420mm H X 297mm W
- A4: 297mm H x 210mm W
- A5: 210mm H x 148mm W



Any requests are welcome at

export@all-round.be

5.6 Pegboard metal prongs

The pegboard metal prongs are suitable for perforated displays. They are recommended to carry heavy products.

PEG14

Single pegboard prong in metal. Fixed hole center of 30mm.

	L	W	☑	🛒
PEG14/100	100mm	25mm	●	
PEG14/140	140mm	25mm		●
PEG14/200	200mm	25mm	●	
PEG14/300	300mm	25mm	●	
PEG14/400	400mm	25mm		●

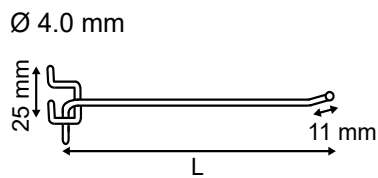

PEG15

Double pegboard prong in metal. Adjustable hole center from 25mm to 30mm.

	L	W	☑	🛒
PEG15/060	60mm	25-30mm		●
PEG15/100	100mm	25-30mm	●	
PEG15/160	160mm	25-30mm	●	
PEG15/200	200mm	25-30mm	●	
PEG15/250	250mm	25-30mm	●	
PEG15/300	300mm	25-30mm	●	
PEG15/340	340mm	25-30mm	●	
PEG15/400	400mm	25-30mm		●

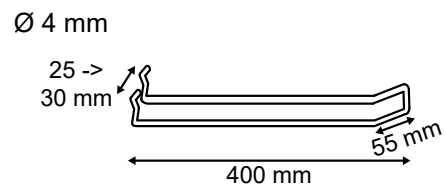
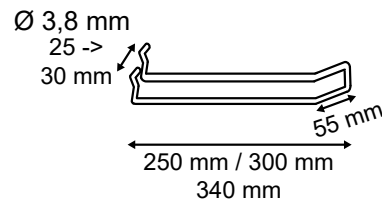
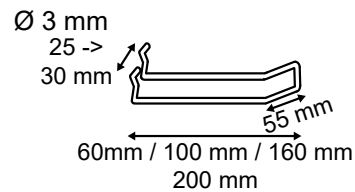

PEG16

Double pegboard prong in metal. Fixed hole center of 45mm.
 → Only supplied on request.

	L	W	☑	🛒
PEG16/100-45	100mm	45mm		●
PEG16/150-45	150mm	45mm		●
PEG16/200-45	200mm	45mm		●
PEG16/250-45	250mm	45mm		●
PEG16/300-45	300mm	45mm		●
PEG16/400-45	400mm	45mm		●

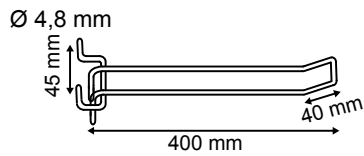
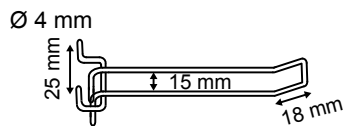
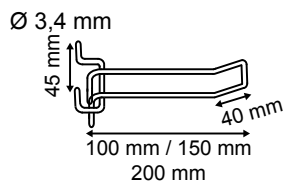

PEG18

Single pegboard hook in metal for couponing. Easy to hang blisters, coupons or shoppers on panels or displays.
 → Fixed hole center of 25mm.

	Ø	FIXED HOLE	☑	🛒
PEG18	10mm	25mm	●	

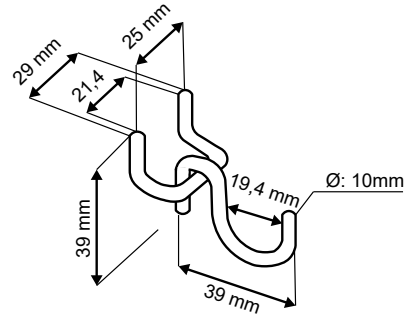

5.7 Stock limiters for prongs

Stock limiters have the advantage of keeping stock at front of merchandising hooks.

PEG20

Stock limiter for a double prong in white PVC.

L	H	COLORS	<input checked="" type="checkbox"/>	
32/26mm	25mm	White	●	

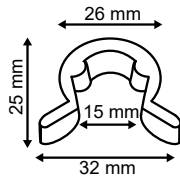

PEG21

Stock limiter for a single prong in white PVC.

L	H	COLORS	<input checked="" type="checkbox"/>	
9mm	18mm	White	●	

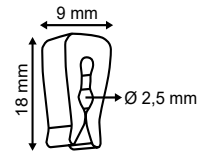

PEG30

Round stock limiter for a single prong in clear plastic with a fixed diameter of 4mm.

Ø	COLORS	<input checked="" type="checkbox"/>	
26mm	Transparent	●	

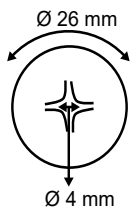

5

5.8 Label holders for prongs

Clear plastic label holders are suitable for plastic or metal double prongs and wire baskets.

PEG32 - PEG17 - PEG33

Label holder for single & double prongs and wire baskets.

	L	W	Ø WIRE	<input checked="" type="checkbox"/>	
PEG32	53mm	33mm	10mm	●	
PEG17	17mm	38mm	5mm	●	
PEG33	28mm	30mm	5mm	●	



LAB20/4065

Label holder for wire basket or "T" wire hooks.

	L	W	DIAMETER WIRE	<input checked="" type="checkbox"/>	
LAB20/4065	65mm	40mm	10mm	●	

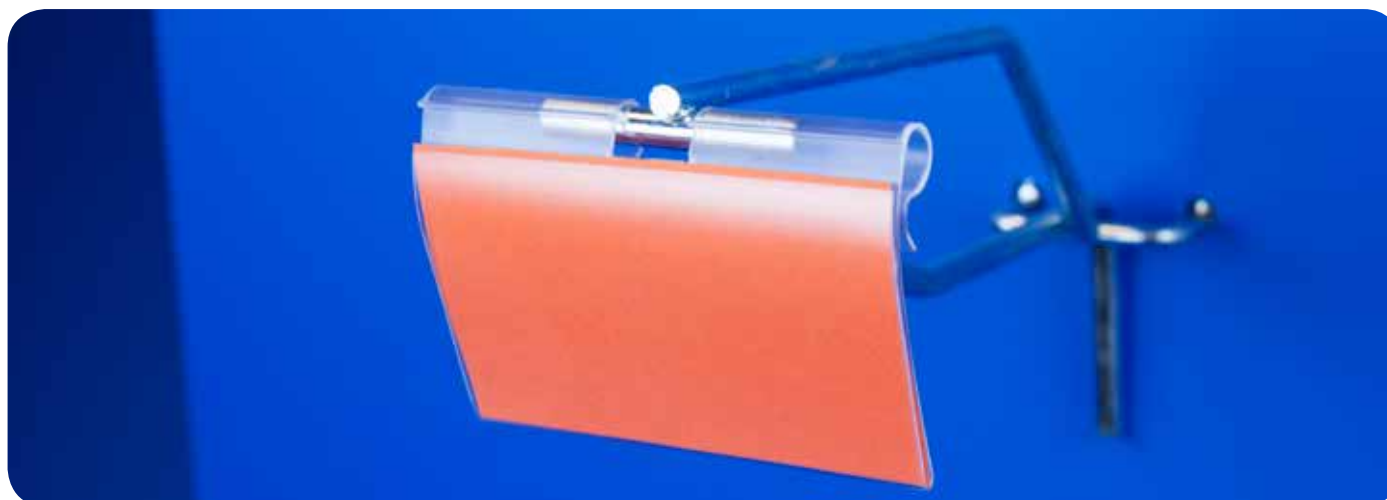

5.9 Anti-theft systems for prongs

Anti-theft systems are a vital and unavoidable system to secure goods & protect retail shops from thefts.

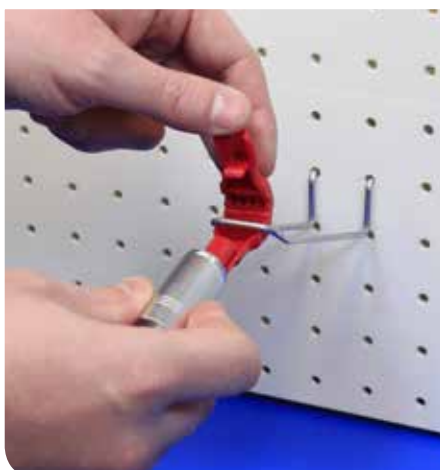

PEG40 - PEG41

Anti-theft system in plastic for double or single prongs. To be used with the magnetic opener (PEG40/MAG), that is sold separately.

→ White color supplied on request.

	COLOR	Ø WIRE	<input checked="" type="checkbox"/>	
PEG40/R	Red	4 to 5mm	●	
PEG40/Z	Black	4 to 5mm	●	
PEG41/R	Red	5 to 6mm	●	
PEG41/Z	Black	5 to 6mm	●	
PEG40/MAG	Magnetic opener.		●	

5.10 Hang Tabs



Our Hang Tabs are 100 % recyclable and environmentally friendly



Numerous businesses are missing out on a number of sales benefits by not being aware of Hang Tabs and the way they can gain from their use.

Hang Tabs can be simply defined as self-adhesive die cut hangers applied to retail products that otherwise had no way to be hung in a retail environment or need their hanging feature reinforced...

Superstores or supermarkets showcase thousands of different products. Getting noticed or standing out amongst those products, without a doubt, is a challenge...

One way to grab the buyer's attention on retail goods is the smart use of self-adhesive hooks where retailers can display merchandise at eye level rather than having to stack it on shelves.

Hanging products brings following benefits:

- Increase sales by creating an attractive display of products.
- An obvious reduction in retail space used
- Significant reduction in packaging when compared to other forms of hang sell like blister packaging or large header cards.
- Fast stock movement resulting in decreased loss for products with limited shelf life

How to choose your HANG TABS :

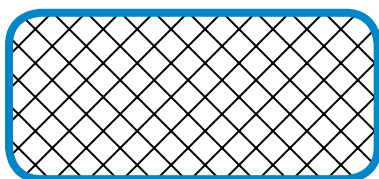

FLEXI TAPE

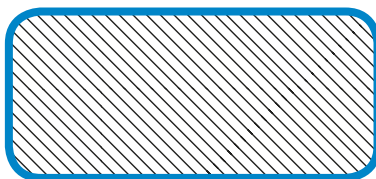

STANDARD TAPE

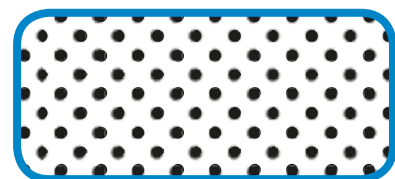

FOAM TAPE



→ can be folded



→ removable waste

L → length | W → width | H → height | Ø → diameter | |H| → capacity | ☑ → stock | 🛒 → on request

hang tabs on a reel

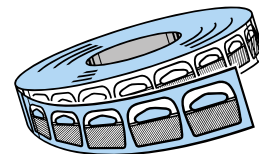

Hang Tabs packed on a reel are designed for automatic application.

It's the most cost-efficient option. The reels can be presented in various re-wind option, core diameters and pack quantities.

	THICKNESS	ADHESIVE H	HOLE	STYLE	<input checked="" type="checkbox"/>	
BLI196	250 μ	25mm	Euroslot	Flexi	•	
BLI364	250 μ	17mm	Euroslot	Flexi	•	
BLI361	500 μ	18mm	Hook	Flexi	•	
BLI362	250 μ	20mm	Round Hole	Flexi	•	
BLI398	250 μ	2x9mm	Delta	Standard	•	
BLI384*	380 μ	18mm	Euroslot	Foam	•	
BLI1/5050	250 μ	28mm	Euroslot	Flexi	•	
BLI154	380 μ	2x18mm	Euroslot	Foam	•	

...* → No automatic application possible

Scale
1/1

BLI196

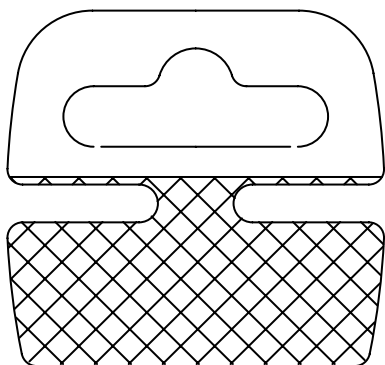

BLI364

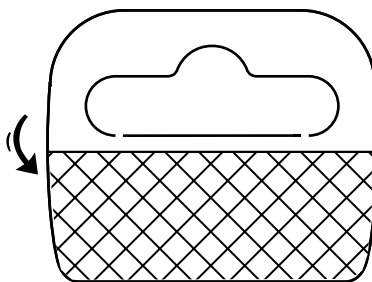

BLI362

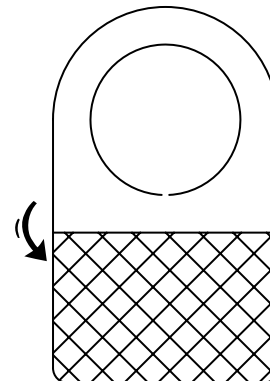

BLI398

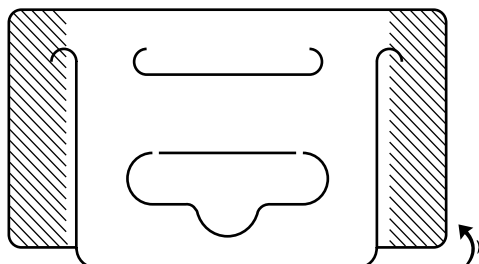

BLI361

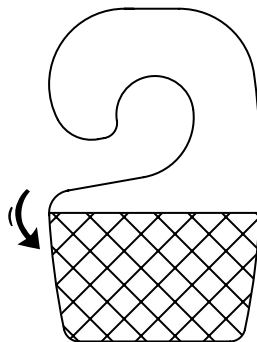

BLI154

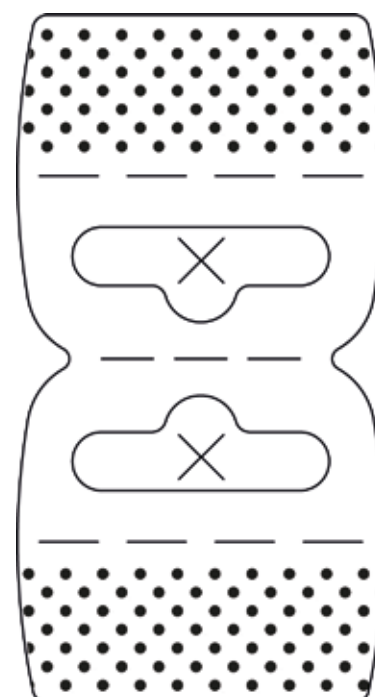

BLI384

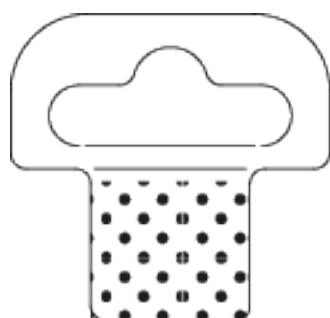

BLI1/5050

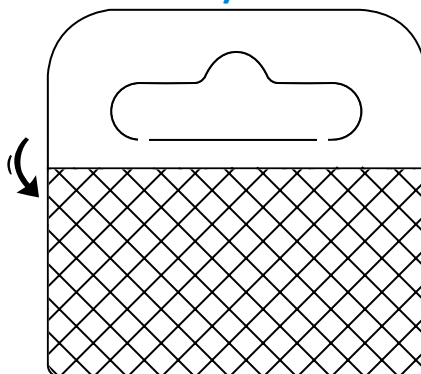

L → length | W → width | H → height | Ø → diameter | → capacity | → stock | → on request

hang tabs on pad blocks



This remarkable format of sticky hooks involves stacking 10 pieces of hang tabs on top of each other. Hang Tabs on pad blocks are packed in boxes of 500 or 1.000 units.

In reconstructing the packaging of some hanging products, the pad format is invaluable and simple to disperse among floor staff. By taking the products into the customers' eye level using hang tabs, it can substantially improve sales. Pad format is very handy, you can carry two hundred (200) hang tabs in your pocket unnoticeably, something not smart with sheet or roll form.

Ordering in extremely high volume, pad form hang tabs is most likely the most cost effective format mainly because of the tiny amount of backing paper it needs as it is shared by the stack. This is not feasible with other formats similar to the sheet or roll form.

The pad format is usually a flexible piece of hang tab where its hanging part is a rigid PET and the lower portion is the sticky section. It is capable to fold up for packing. For example, if a manufacturer adding hanging option at the top of their products with the use of flexible Euro Slot hang tabs, they still can use their regular same shipping cartons as the euro slot hang tabs are flexible.

	Thickness	Adhesive	Hole	Packing	<input checked="" type="checkbox"/>	
BLI5	250 μ	Flexi	Euroslot	500	•	
BLI5/1000	250 μ	Flexi	Euroslot	1.000	•	
BLI1001	250 μ	Flexi	Delta	1.000	•	
BLI11	75 μ	Flexi	Hang Strap	1.000	•	

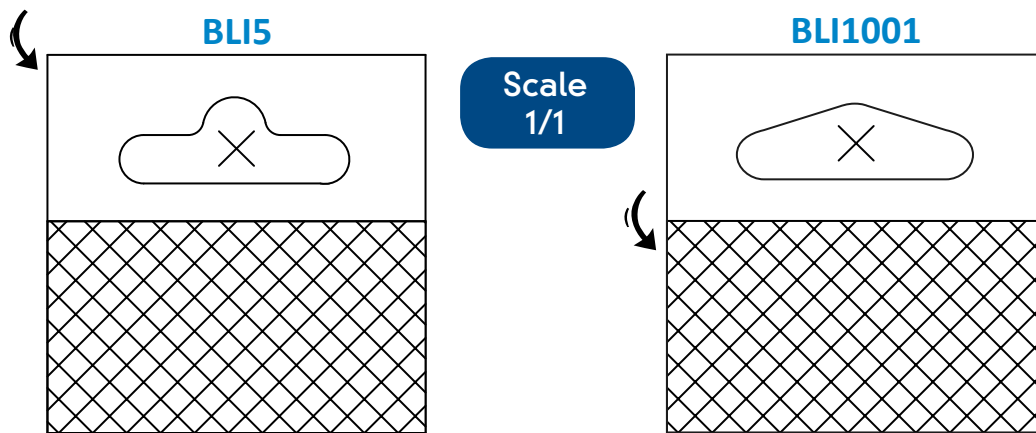

BLI11

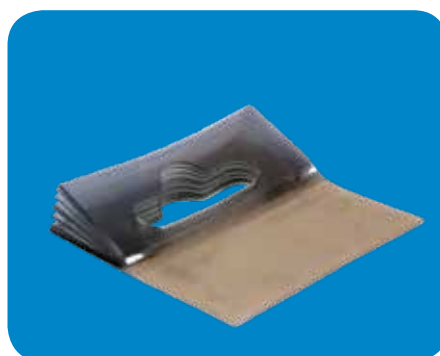

Loose hang tabs

For small production runs, hand application is the usual method. Loose Hang Tabs will help to keep costs down and is the least expensive way to test a new Hang Tab design on your product before committing to greater quantities.

Loose Hang tabs include Easy Peel at no extra cost.

	Thickness	Adhesive	Hole	Packing	<input checked="" type="checkbox"/>	
BLI1/4035	380 μ	Easy Peel	Delta	2.000	•	
BLI325	380 μ	Easy Peel	Euroslot	2.000	•	
BLI2/2740	500 μ	Easy Peel	Hook	2.000	•	

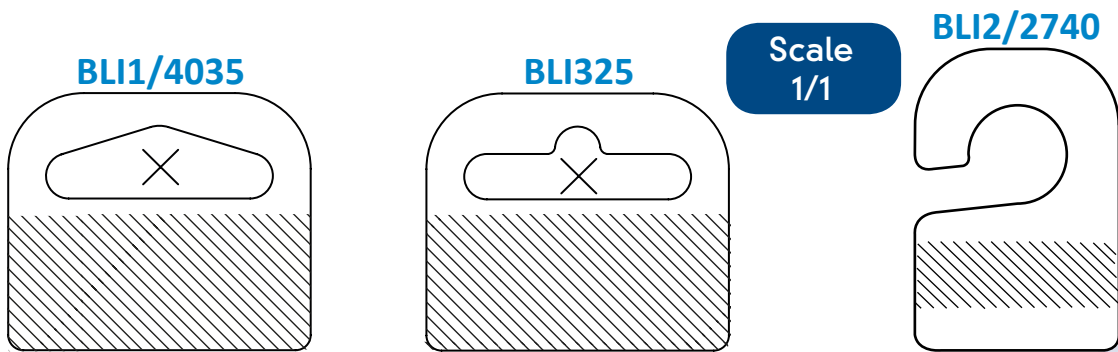

hang tabs on sheets

The size of the sheet makes the application of Hang Tabs fast and easy: just peel and apply on any lightweight pack. Three different styles (hole, euro slot, hook) are available to display a wide range of packs on all types of shelving.

	Thickness	Adhesive	Hole	Packing	<input checked="" type="checkbox"/>	
BLI55429	250 μ	Flexi	Double Euroslot	1.000	•	
BLI550185	250 μ	Standard reinforce	Double Euroslot	1.000	•	



5.11 Turn tables

Turn tables are designed to turn displays or products on the flat surfaces.

TAB3

Turntable with inside ball-bearing.

	DIAMETER	COLORS	<input checked="" type="checkbox"/>	
TAB3/100/T	100mm	Transparent	•	
TAB3/150/W	150mm	White	•	
TAB3/225/W	225mm	White	•	

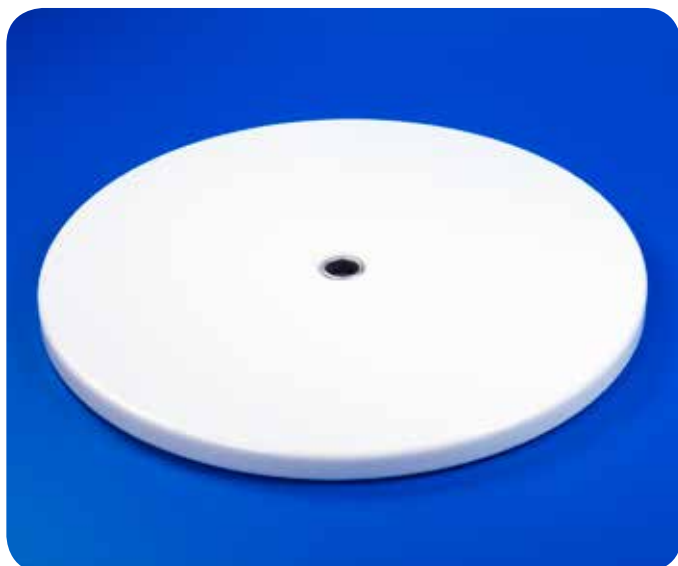

5.12 Cardboard tube accessories

A variety of accessories to enable advertising and promotion on tubes.

CLI13/25

Fitting clip in steel with a perforation hole for cardboard tube.

	L	Ø TUBE	Ø HOLE	<input checked="" type="checkbox"/>	
CLI13/25	30mm	25mm	3mm	•	

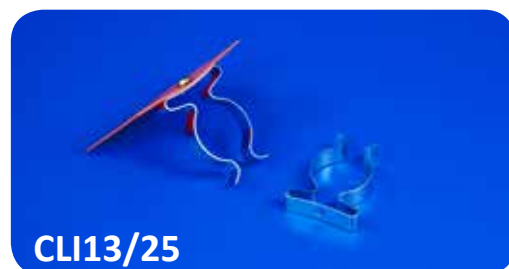

CLI13/25

POL2 – POL3

Self-adhesive fitting clip in white PVC for tubes or cardboard tubes.

	L	B	Ø TUBE	<input checked="" type="checkbox"/>	
POL2	20mm	15mm	22mm	•	
POL3	73mm	25mm	33mm		•



POL2



POL3

5.13 Display feet accessories

Display feet are designed to protect and to support your free-standing display.



COR3

Display foot in white styrene with an 90° angle. Keeps the display 10mm above the ground.

L	H	↔	COLOR	☑	🛒
64mm	25+10mm	4mm	White	•	



COR4

Display foot clear polypropylene with an adjustable angle. Keeps the display 11mm above the ground.

L	H	↔	COLOR	☑	🛒
49mm	29+11mm	3-6mm	White	•	



COR5

Self-adhesive display foot in clear polypropylene. Enables easy moving of the display. Keeps the display 25mm above the ground.

L	H	Ø BOWL	COLOR	☑	🛒
50mm	25mm	35mm	Clear	•	



5.14 Display assembly accessories

Display assembly accessories are designed to assemble your displays.

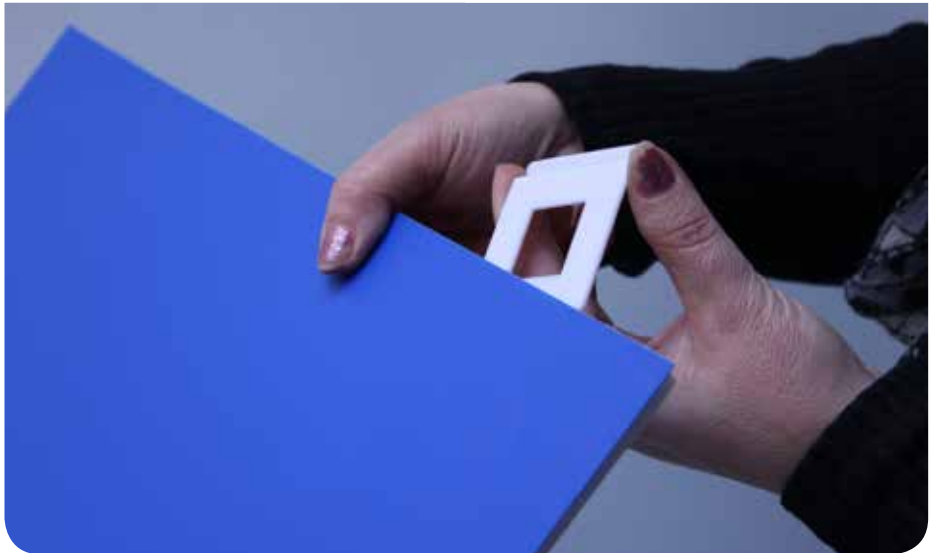
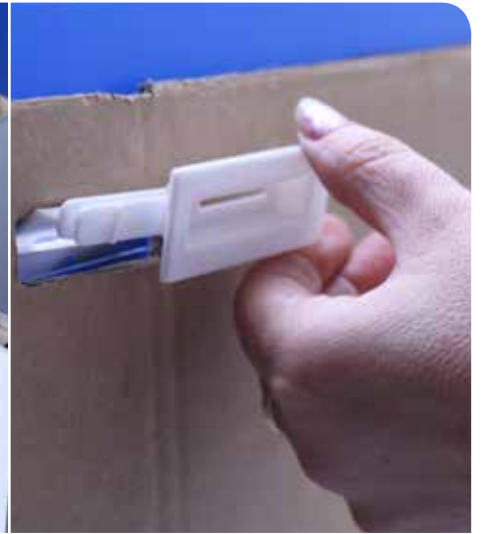
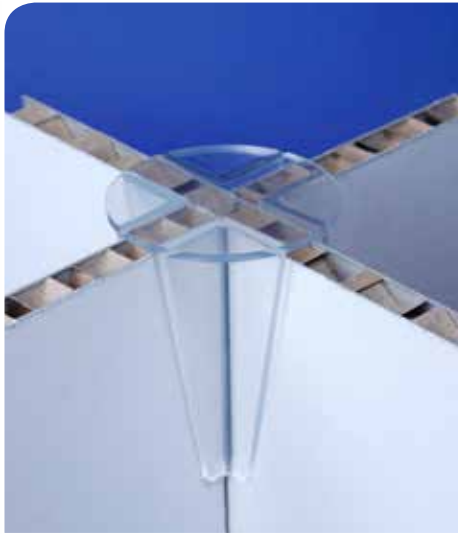

COR1

4-Way display clip in clear plastic, keeps display boxes and cartons securely together.

H	∅	↳↳	☑	🛒
80mm	50mm	10mm	•	

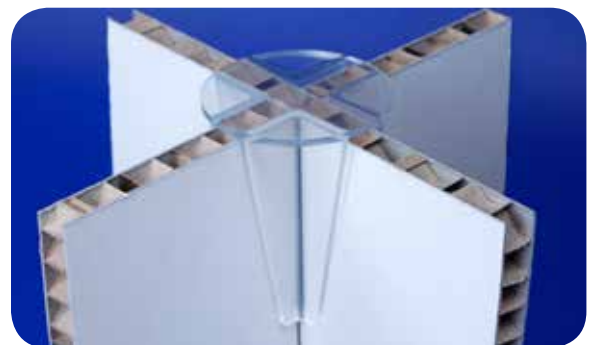

COR2

Display clip in clear plastic, connects corrugated display panels together and provides a secure hold without adhesive.

H	W	↳↳	☑	🛒
52mm	49mm	Max 8mm	•	



L → length | W → width | H → height | ∅ → diameter | ↳↳ → capacity | ☑ → stock | 🛒 → on request

COR10

Shelf clip in white polypropylene to assemble shelves in the cardboard displays.

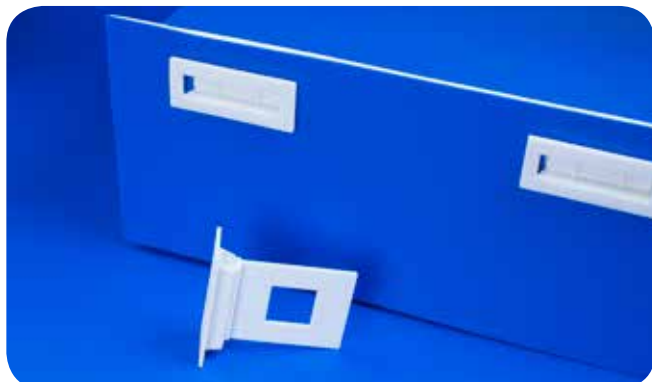

→ Custom colors supplied on request.

	PART 1	PART 2	ANGLE	<input checked="" type="checkbox"/>	
COR10	26x65mm	47x55mm	90 °	•	
COR10/45	26x45mm	47x55 mm	45 °	•	



COR11

Assembly connector in white ABS, for bonding into corrugated cardboard free-standing displays.

L	H	TOTAL H		<input checked="" type="checkbox"/>	
40mm	36mm	81mm	4mm	•	



COR19

Screw to be used with honeycomb cardboard and/or polystyrene.

L	Ø TOP	Ø END	COLOR	<input checked="" type="checkbox"/>	
55mm	14mm	12mm	Transparent	•	



LAB16

Clear PVC flexible hinged profile with foam adhesive.

H	W	ADHESIVE	<input checked="" type="checkbox"/>	
1000mm	2x13mm	Permanent	•	



5.15 LED display accessories

Flashing LED lights attracts customers' attention. It produces high brightness and excellent visibility.

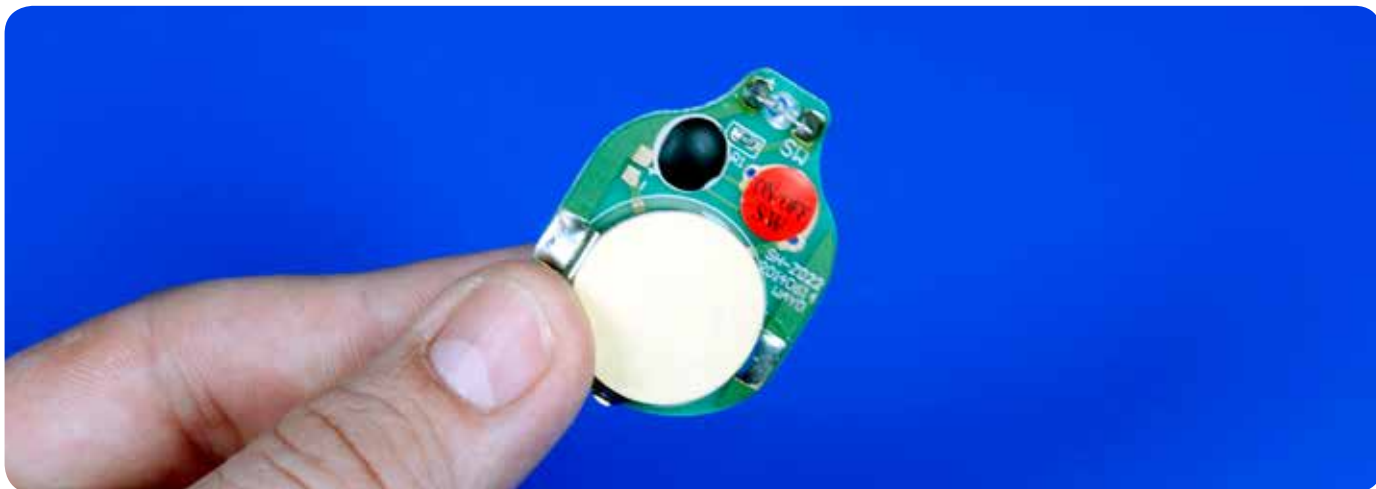

LED1

Flashing LED light, with a power switch button
The battery cannot be replaced.

	LED Ø	COLOR LED	BATTERY	<input checked="" type="checkbox"/>	
LED1/W	3mm	White	90days	•	
LED1/R	3mm	Red	90days	•	
LED1/B	3mm	Blue	90days	•	
LED1/G	3mm	Green	90days		•
LED1/Y	3mm	Yellow	90days		•



5

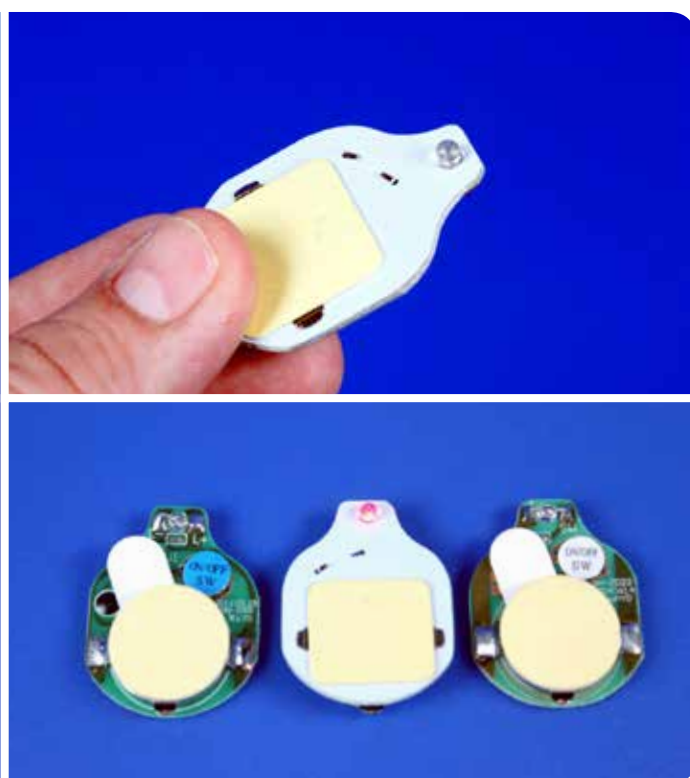

L → length | W → width | H → height | Ø → diameter | → capacity | → stock | → on request

6. Printing Accessories

Looking for the finishing touch for your project? In our printing accessories range you can find a large number of small finishing products that totally pimp your presentation. From buttons to velcro, adhesive tape and magnetic strips, both permanent and removable.

For large and smaller products that are tied together, you can use our handy rings and ball chains.

You can't really find what you are looking for? It will be our team's pleasure to think along with you. Don't hesitate to contact them for an appointment in order to find the perfect solution together.

6.1 Push buttons

6.2 Screws

6.3 Hook & loop fasteners

6.4 Adhesive pads

6.5 Adhesive tapes

6.6 Glue dots

6.7 Magnetic discs

6.8 Magnetic tapes

6.9 File prongs & accessories

6.10 CD accessories

6.11 Ball chains & accessories

6.12 Rings & hooks

6.1 Push buttons

A large range of push buttons is offered to securely hold your point of sale media. They are fitted with permanent or re-usable closures as well as different capacities to satisfy any need.

DIS4

Push button in clear plastic with permanent closure.

→ Custom colors or lengths supplied on request.

	L.TUBE	Ø HEAD	Ø SHAFT	COLOR	<input checked="" type="checkbox"/>	
DIS4/6	6mm	14mm	5mm	Transparent		●
DIS4/12	12mm	14mm	5mm	Transparent		●
DIS4/22	22mm	14mm	5mm	Transparent	●	

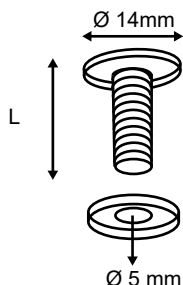

DIS6

Thumb snap in clear polypropylene with permanent closure.

→ Custom colors or lengths supplied on request.

	L.TUBE	Ø HEAD	Ø SHAFT	COLOR	<input checked="" type="checkbox"/>	
DI6/A	3mm	12mm	9mm	Transparent	●	
DIS6/B	6mm	12mm	9mm	Transparent	●	
DIS6/C	9mm	12mm	9mm	Transparent	●	
DIS6/D	12mm	12mm	9mm	Transparent	●	

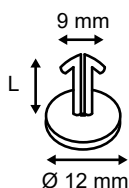

DIS8

Push button in polypropylene with permanent closure.

→ Custom colors or lengths supplied on request.

	L.TUBE	Ø HEAD	Ø SHAFT	COLOR	<input checked="" type="checkbox"/>	
DIS8/2.5	2,5mm	12mm	9mm	White	●	
DIS8/2.5/Z	2,5mm	12mm	9mm	Black	●	
DIS8/5	5mm	12mm	9mm	White	●	
DIS8/5/Z	5mm	12mm	9mm	Black	●	
DIS8/7.5	7,5mm	12mm	9mm	White	●	
DIS8/7.5/Z	7,5mm	12mm	9mm	Black	●	

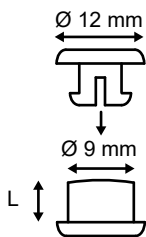

DIS9

Push button in clear plastic, provided with a perforation hole and a permanent closure.

→ Custom colors or lengths supplied on request.

	L.TUBE	Ø HEAD	Ø SHAFT	Ø HOLE	COLOR	<input checked="" type="checkbox"/>	
DIS9/2.5	2.5mm	12mm	5mm	2mm	Transparent		●
DIS9H/3	3mm	12mm	5mm	2mm	Transparent		●
DIS9/5	5mm	12mm	5mm	2mm	Transparent	●	

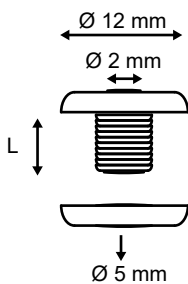

DIS15

Push button in plastic with a permanent closure.

→ Custom colors or lengths supplied on request.

	L.TUBE	Ø HEAD	Ø SHAFT	COLOR	<input checked="" type="checkbox"/>	
DIS15/1.5	1.5mm	15mm	5mm	White	●	
DIS15/1.5/T	1.5mm	15mm	5mm	Transparent	●	
DIS15/1.5/Z	1.5mm	15mm	5mm	Black	●	
DIS15/2.5	2.5mm	15mm	5mm	White	●	
DIS15/2.5/T	2.5mm	15mm	5mm	Transparent	●	
DIS15/2.5/Z	2.5mm	15mm	5mm	Black	●	
DIS15/3.5	3.5mm	15mm	5mm	White	●	

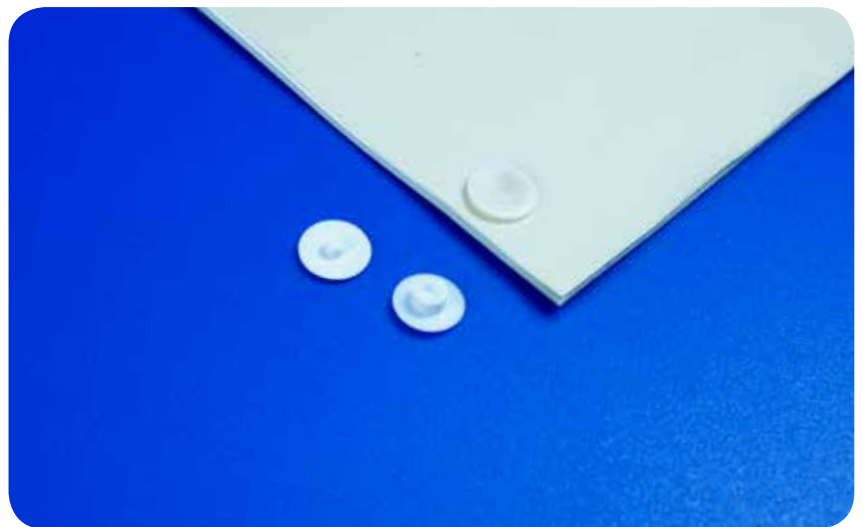
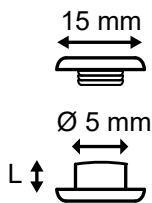



DIS16

Spread rivet in plastic with an assembly capacity to 14mm.

→ Custom colors or lengths supplied on request.

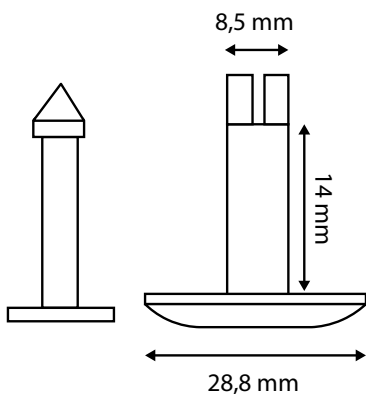
	L.TUBE	Ø HEAD	Ø SHAFT	COLOR	<input checked="" type="checkbox"/>	
DIS16/T	14mm	28,8mm	8,5mm	Transparent	●	
DIS16/W	14mm	28,8mm	8,5mm	White	●	
DIS16/Z	14mm	28,8mm	8,5mm	Black	●	



L → length | W → width | H → height | Ø → diameter |  → capacity | → stock |  → on request

DIS19

Push button in clear polypropylene. The large diameter provides more strength and grip.

→ Custom colors or lengths supplied on request.

	L.TUBE	Ø HEAD	Ø SHAFT	COLOR	☑	🛒
DIS19/16	16mm	30mm	5,5mm	Transparent	•	
DIS19/22	22mm	30mm	5,5mm	Transparent	•	
DIS19/38	38mm	30mm	5,5mm	Transparent	•	

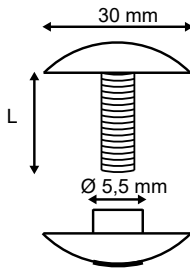

All Round is a **hang tabs** manufacturer

Manufacturing by All Round gives complete control so that we can give our customers the best product, service and price.

Beyond our standard **hang tabs** range included in this catalogue, we have an additional range of stock Hang Tabs available for next day delivery.

- Clear recyclable PET
- Different types of adhesives and thicknesses
- Always ex stock

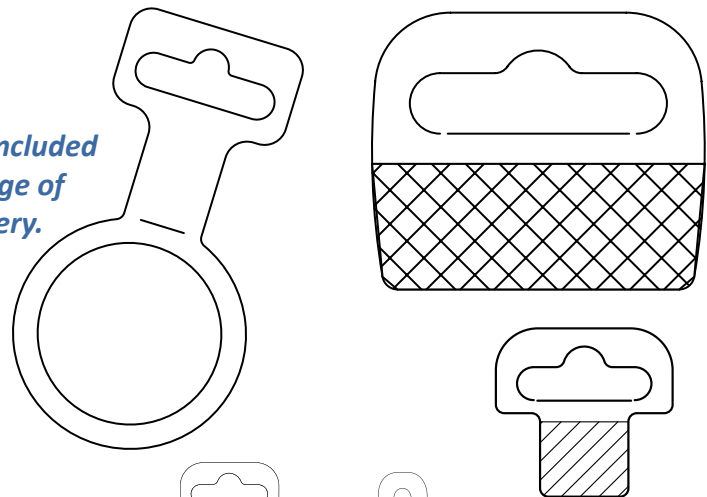

Feel free to ask for our complete **hang tabs** catalogue

export@all-round.be

6.2 Screws

An exhaustive range of screws of various diameters available in different finishes and colours to securely hold your media.

DIS5

Reusable screw lock in clear plastic with wingnuts.
 → Custom colors or lengths supplied on request.

	L.TUBE	Ø HEAD	Ø SHAFT	COLOR	☑	🛒
DIS5/A	13mm	14mm	5mm	Transparent	●	
DIS5/B	20mm	14mm	5mm	Transparent		●
DIS5/C	25mm	14mm	5mm	Transparent	●	

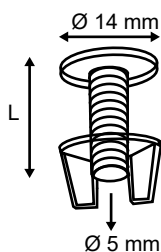

DIS13

Reusable screw lock in nylon or metal.
 → Custom colors or lengths supplied on request.

	L.TUBE	Ø HEAD	Ø SHAFT	COLOR	☑	🛒
DIS13/V2	2mm	12mm	5mm	Chrome	●	
DIS13/M2	2mm	12mm	5mm	Brass	●	
DIS13/3,5	3,5mm	12mm	5mm	White	●	
DIS13/3,5/Z	3,5mm	12mm	5mm	Black	●	
DIS13/V3,5	3,5mm	12mm	5mm	Chrome	●	
DIS13/M3,5	3,5mm	12mm	5mm	Brass	●	
DIS13/5	5mm	12mm	5mm	White	●	
DIS13/T/05	5mm	12mm	5mm	Transparent	●	
DIS13/5/Z	5mm	12mm	5mm	Black	●	
DIS13/V5	5mm	12mm	5mm	Chrome	●	
DIS13/M5	5mm	12mm	5mm	Brass	●	
DIS13/8	8mm	12mm	5mm	White	●	
DIS13/8/Z	8mm	12mm	5mm	Black	●	
DIS13/V8	8mm	12mm	5mm	Chrome	●	
DIS13/M8	8mm	12mm	5mm	Brass	●	

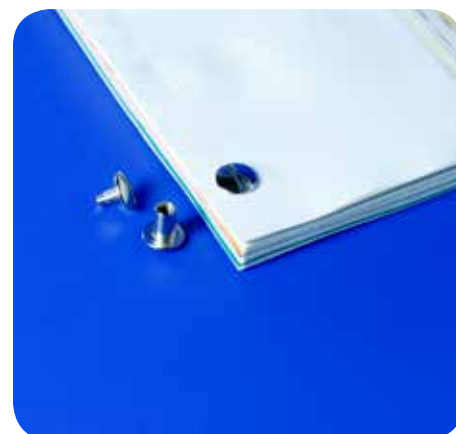

L → length | W → width | H → height | Ø → diameter | → capacity | ☑ → stock | 🛒 → on request

	L.TUBE	Ø HEAD	Ø SHAFT	COLOR	☑	🛒
DIS13/10	10mm	12mm	5mm	White	●	
DIS13/T/10	10mm	12mm	5mm	Transparent	●	
DIS13/10/Z	10mm	12mm	5mm	Black	●	
DIS13/V10	10mm	12mm	5mm	Chrome	●	
DIS13/M10	10mm	12mm	5mm	Brass	●	
DIS13/12	12mm	12mm	5mm	White	●	
DIS13/12/Z	12mm	12mm	5mm	Black	●	
DIS13/V12	12mm	12mm	5mm	Chrome	●	
DIS13/M12	12mm	12mm	5mm	Brass	●	
DIS13/15	15mm	12mm	5mm	White	●	
DIS13/T/15	15mm	12mm	5mm	Transparent	●	
DIS13/15/Z	15mm	12mm	5mm	Black	●	
DIS13/V15	15mm	12mm	5mm	Chrome	●	
DIS13/M15	15mm	12mm	5mm	Brass	●	
DIS13/20	20mm	12mm	5mm	White	●	
DIS13/T/20	20mm	12mm	5mm	Transparent	●	
DIS13/20/Z	20mm	12mm	5mm	Black	●	
DIS13/V20	20mm	12mm	5mm	Chrome	●	
DIS13/M20	20mm	12mm	5mm	Brass	●	
DIS13/25	25mm	12mm	5mm	White	●	
DIS13/25/Z	25mm	12mm	5mm	Black		●
DIS13/V25	25mm	12mm	5mm	Chrome		●
DIS13/M25	25mm	12mm	5mm	Brass		●
DIS13/30	30mm	12mm	5mm	White	●	
DIS13/30/Z	30mm	12mm	5mm	Black		●
DIS13/V30	30mm	12mm	5mm	Chrome		●
DIS13/M30	30mm	12mm	5mm	Brass		●
DIS13/35	35mm	12mm	5mm	White		●
DIS13/35/Z	35mm	12mm	5mm	Black		●
DIS13/V35	35mm	12mm	5mm	Chrome		●
DIS13/M35	35mm	12mm	5mm	Brass		●
DIS13/40	40mm	12mm	5mm	White		●
DIS13/40/Z	40mm	12mm	5mm	Black		●
DIS13/V40	40mm	12mm	5mm	Chrome		●
DIS13/M40	40mm	12mm	5mm	Brass		●
DIS13/45	45mm	12mm	5mm	White		●
DIS13/45/Z	45mm	12mm	5mm	Black		●
DIS13/V45	45mm	12mm	5mm	Chrome		●
DIS13/M45	45mm	12mm	5mm	Brass		●



6

	L.TUBE	Ø HEAD	Ø SHAFT	COLOR	☑	🛒
DIS13/50	50mm	12mm	5mm	White		●
DIS13/50/Z	50mm	12mm	5mm	Black		●
DIS13/V50	50mm	12mm	5mm	Chrome		●
DIS13/M50	50mm	12mm	5mm	Brass		●
DIS13/60	60mm	12mm	5mm	White		●
DIS13/60/Z	60mm	12mm	5mm	Black		●
DIS13/V60	60mm	12mm	5mm	Chrome		●
DIS13/M60	60mm	12mm	5mm	Brass		●
DIS13/70	70mm	12mm	5mm	White		●
DIS13/70/Z	70mm	12mm	5mm	Black		●
DIS13/V70	70mm	12mm	5mm	Chrome		●
DIS13/M70	70mm	12mm	5mm	Brass		●
DIS13/80	80mm	12mm	5mm	White		●
DIS13/80/Z	80mm	12mm	5mm	Black		●
DIS13/V80	80mm	12mm	5mm	Chrome		●
DIS13/M80	80mm	12mm	5mm	Brass		●
DIS13/90	90mm	12mm	5mm	White		●
DIS13/90/Z	90mm	12mm	5mm	Black		●
DIS13/V90	90mm	12mm	5mm	Chrome		●
DIS13/M90	90mm	12mm	5mm	Brass		●



DIS130

Reusable nylon screw lock with a perforation hole.
 → Custom colors or lengths supplied on request.

	L.TUBE	Ø HEAD	Ø SHAFT	Ø HOLE	COLOR	☑	🛒
DIS130/03,5	3,5mm	12mm	6mm	2mm	White	●	
DIS130/05	5mm	12mm	6mm	2mm	White	●	
DIS130/05/Z	5mm	12mm	6mm	2mm	Black	●	
DIS130/10	10mm	12mm	6mm	2mm	White	●	
DIS130/10/Z	10mm	12mm	6mm	2mm	Black	●	
DIS130/15	15mm	12mm	6mm	2mm	White		●
DIS130/15/Z	15mm	12mm	6mm	2mm	Black		●
DIS130/20	20mm	12mm	6mm	2mm	White		●



L → length | W → width | H → height | Ø → diameter | |H| → capacity | ☑ → stock | 🛒 → on request

DIS13/ACC/LUS

Swatch strap in white nylon for integrating into binding screws. Straps occupy approximately 4mm of the filling level (2 x 2mm).

	L	Ø HEAD	Ø SHAFT	COLOR	<input checked="" type="checkbox"/>	
DIS13/ACC/LUS	145mm	14mm	5mm	White	•	

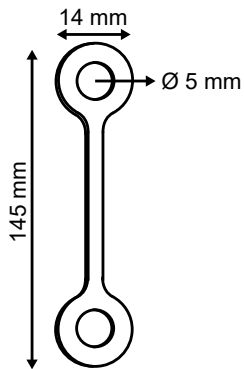

DIS13/ACC/OOG

Screw lock hanger in metal for integrating into binding screws. Capacity loss of 1mm.

	L	W	Ø HOLE	COLOR	<input checked="" type="checkbox"/>	
DIS13/ACC/OOG	20mm	14mm	5mm	Chrome	•	

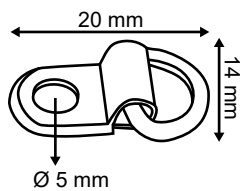

6.3 Hook & loop fasteners

Our Hook & Loop is a heavy duty industrial product, that will survive most elements thrown at it. It will survive in the wet, and in the sun for many years. Our self-adhesive fasteners is a generic peel and stick product, that performs well with adequate surface preparation and cleaning prior to application.

Hook is the rough, scratchy part - in self-adhesive is the more purchased with people buying to put onto signs, banners or posters to put up on their walls at the point of sale, or on the walls already lined at expos.

Loop is the soft, fluffy part – mostly used to apply to the wall/more permanent surface of the two; a hook & loop pair would be applied to.

VEL10

Self-adhesive hook and loop coin fasteners (delivered on separate rolls).

	Ø	HOOK / LOOP	COLOR	COINS/ROLL	<input checked="" type="checkbox"/>	
VEL10/13	13mm	Loop	White	1500pcs	●	
VEL10/13H	13mm	Hook	White	1500pcs	●	
VEL10/13/Z	13mm	Loop	Black	1500pcs		●
VEL10/13H/Z	13mm	Hook	Black	1500pcs		●
VEL10/16	16mm	Loop	White	1250pcs	●	
VEL10/16H	16mm	Hook	White	1250pcs	●	
VEL10/22	22mm	Loop	White	1000pcs	●	
VEL10/22H	22mm	Hook	White	1000pcs	●	
VEL10/33	33mm	Loop	White	650pcs	●	
VEL10/33H	33mm	Hook	White	650pcs	●	
VEL10/35	35mm	Loop	White	600pcs		●
VEL10/35H	35mm	Hook	White	600pcs		●
VEL10/45	45mm	Loop	White	480pcs		●
VEL10/45H	45mm	Hook	White	480pcs		●



L → length | W → width | H → height | Ø → diameter |  → capacity | → stock |  → on request

VEL11

Self-adhesive "Easy Peel" hook and loop oval fasteners (on roll in pairs).

→ Available in white or black color.

	L	W	COLOR	COINS/ ROLL	<input checked="" type="checkbox"/>	
VEL11	35mm	12mm	White	3300pcs	●	
VEL11/Z	35mm	12mm	Black	3300pcs	●	



VEL12

Self-gripping Velcro cable ties. Hook and loop combined in the same tie.

	L	W	COLOR	QUANTITY/ ROLL	<input checked="" type="checkbox"/>	
VEL12/150	150mm	20mm	Black	1000pcs	●	
VEL12/200	200mm	20mm	Black	750pcs	●	



VEL20

Self-adhesive hook and loop fasteners (delivered on separate rolls).

→ Supplied in 25m rolls

	W	HOOK / LOOP	COLOR	<input checked="" type="checkbox"/>	
VEL20/16	16mm	Loop	White	●	
VEL20/16H	16mm	Hook	White	●	
VEL20/20	20mm	Loop	White	●	
VEL20/20H	20mm	Hook	White	●	
VEL20/25	25mm	Loop	White	●	
VEL20/25H	25mm	Hook	White	●	
VEL20/25/Z	25mm	Loop	Black	●	
VEL20/25H/Z	25mm	Hook	Black	●	
VEL20/30	30mm	Loop	White	●	
VEL20/30H	30mm	Hook	White	●	
VEL20/38	38mm	Loop	White	●	
VEL20/38H	38mm	Hook	White	●	
VEL20/50	50mm	Loop	White	●	
VEL20/50H	50mm	Hook	White	●	

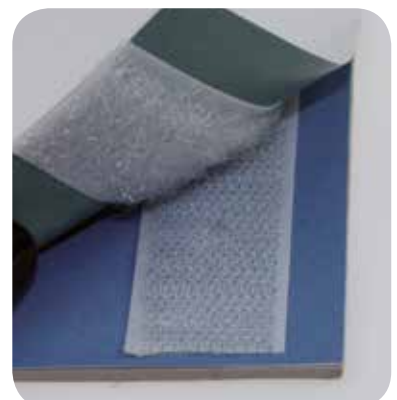

6.4 Adhesive pads

A large product range to choose from (permanent or removable features), adhesive pads are ideal for thousands of gluing attachments or assembly packaging applications.

FOA1

Double-sided permanent adhesive foam pads.

→ Supplied on rolls.

	L	W	THICKNESS	COLOR	ADHESIVE	PADS/ROLL	<input checked="" type="checkbox"/>	
FOA1/A	12mm	12mm	1mm	White	Foam/Permanent	1000pcs	●	
FOA1/B	25mm	12mm	1mm	White	Foam/Permanent	1000pcs	●	
FOA1/C	25mm	25mm	1mm	White	Foam/Permanent	500pcs	●	

FOA 1/A

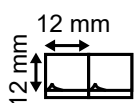

FOA 1/B

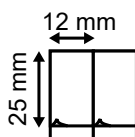

FOA 1/C

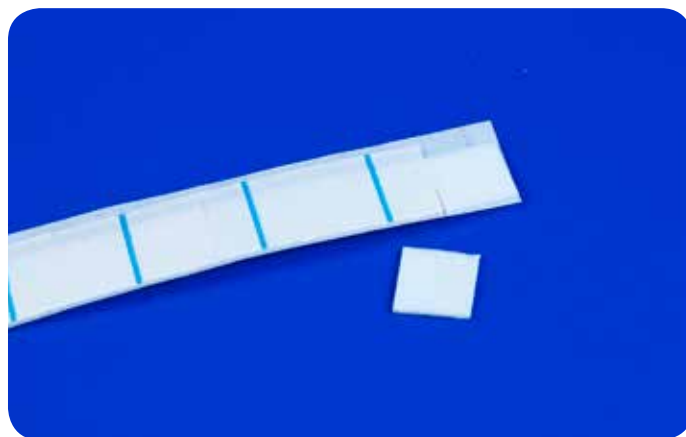
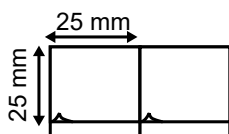

FOA1/DR

Double-sided "Easy Peel" permanent / removable adhesive foam pads.

→ Supplied on sheets.

	L	W	THICKNESS	COLOR	ADHESIVE	PADS/ROLL	<input checked="" type="checkbox"/>	
FOA1/DR	24mm	24mm	1mm	White	Foam Permanent/Removable	20pcs	●	

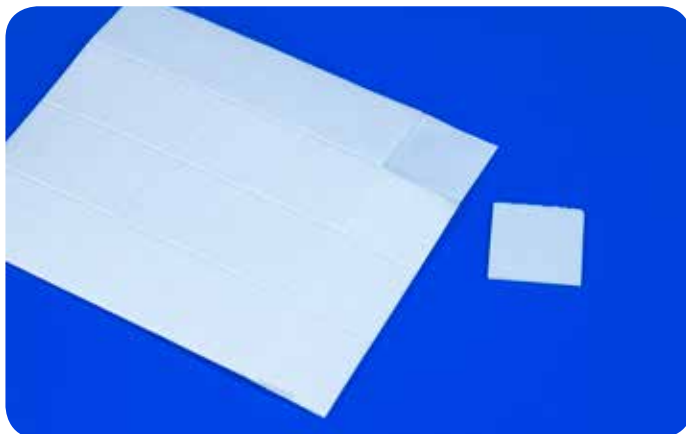
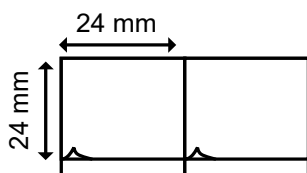

FOA1/R20

Double-sided round « Easy Peel » permanent adhesive foam pads.

→ Supplied on rolls.

	Ø	THICKNESS	COLOR	ADHESIVE	PADS/ROLL	<input checked="" type="checkbox"/>	
FOA1/R20	18mm	0.8mm	White	Foam Permanent	5000pcs	•	

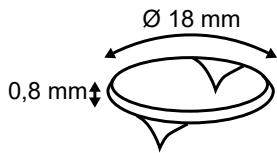

FOA4/RT15

Double-sided round “Easy Peel” removable adhesive pads.

→ Supplied on rolls.

	Ø	THICKNESS	COLOR	ADHESIVE	PADS/ROLL	<input checked="" type="checkbox"/>	
FOA4/RT15	15mm	1mm	Transparent	Acryl Removable	5000pcs	•	

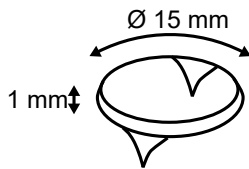

FOA10/25

Double-sided “Easy Peel” removable acrylic adhesive pads.

→ Supplied on sheets in a pouch.

	L	W	THICKNESS	COLOR	ADHESIVE	PADS/POCKET	<input checked="" type="checkbox"/>	
FOA10/25	25mm	25mm	1mm	Transparent	Acryl Removable	240pcs	•	

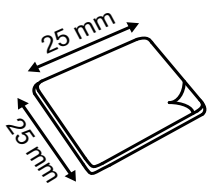

FOA11

Double-sided "Easy Peel" permanent adhesive foam pad spacers.
 → Supplied on rolls.

	L	W	THICKNESS	COLOR	ADHESIVE	PADS/POCKET	<input checked="" type="checkbox"/>	
FOA11	12mm	12mm	4.3mm	White	Foam Permanent	1500pcs	●	

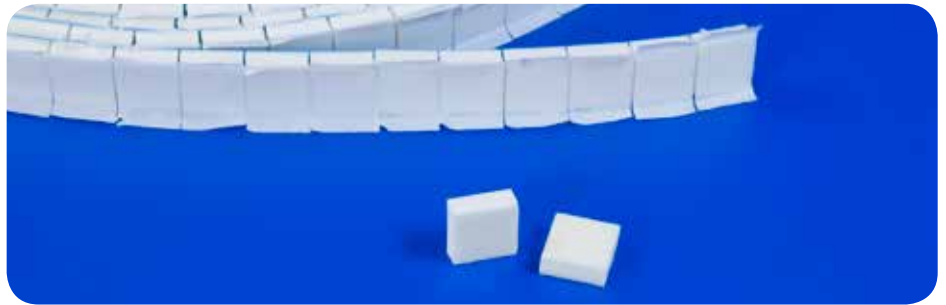
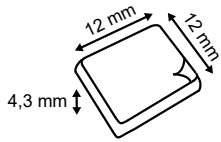

FOA2/R20

Double-sided round "Easy Peel" permanent / removable acrylic adhesive discs.
 → Supplied on rolls.

	Ø	COLOR	ADHESIVE	PADS/ROLL	<input checked="" type="checkbox"/>	
FOA2/R20	20mm	Transparent	Acryl Permanent/Removable	5000pcs	●	

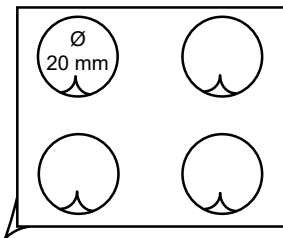

FOA8

Double-sided round "Easy Peel" permanent / removable acrylic adhesive discs.
 → Supplied on rolls.

	DIAMETER	ADHESION	PERFORATION	QUANTITY	<input checked="" type="checkbox"/>	
FOA8/R20	20mm	Acryl Permanent	/	5000pcs	●	
FOA8/R20R	20mm	Acryl Removable	/	1000pcs	●	
FOA8/R25R	25mm	Acryl Permanent	●	2000pcs	●	
FOA8/R50	50mm	Acryl Permanent	/	2000pcs		●

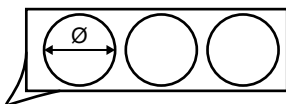

L → length | W → width | H → height | Ø → diameter | → capacity | → stock | → on request

BLI340

Self adhesive oval dots to close or fasten bags or packings.

→ Supplied on rolls

	L	I	THICKNESS	COLOR	ADHESIVE	PADS/ROLL	<input checked="" type="checkbox"/>	
BLI340	50mm	24mm	75μ	Transparent	FLEXI	2000pcs	<input type="checkbox"/>	

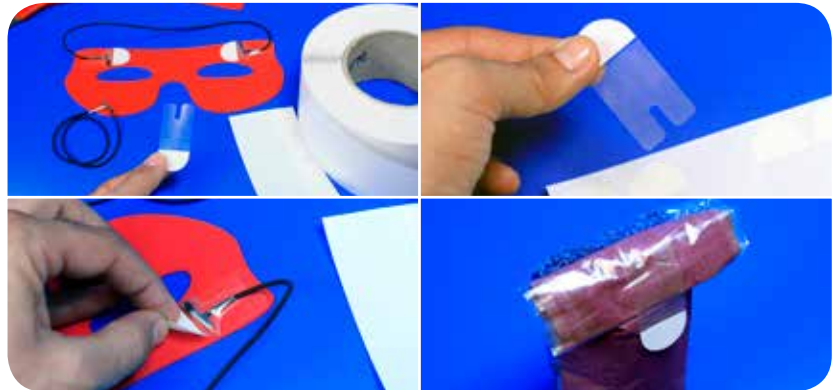
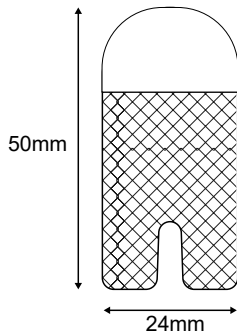

DOT6

Double-sided "Easy Peel" removable acrylic adhesive pads.

→ Supplied on sheets.

	L	W	THICKNESS	COLOR	ADHESIVE	PADS/SHEET	<input checked="" type="checkbox"/>	
DOT6	22mm	22mm	1mm	Transparent	Acryl Removable	20pcs	<input type="checkbox"/>	

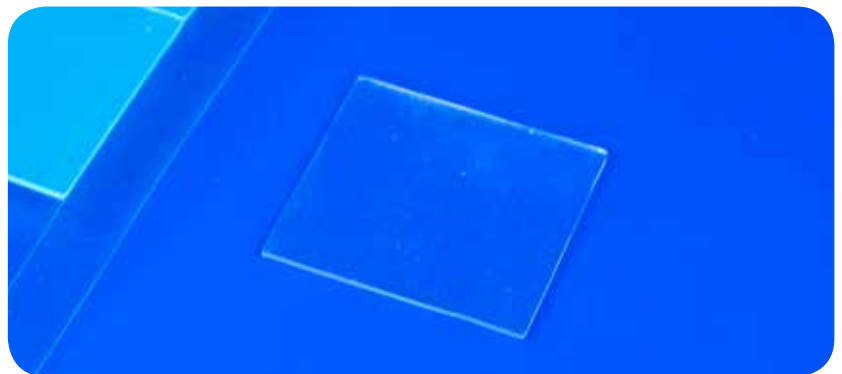
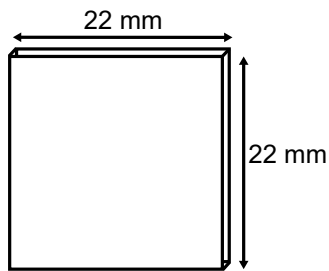

DOT4

Round self-adhesive bumpers.

	Ø	THICKNESS	COLOR	PADS/SHEET	<input checked="" type="checkbox"/>	
DOT4	8.5mm	2.2mm	Transparent	450pcs	<input type="checkbox"/>	<input type="checkbox"/>
DOT4/19	19mm	1.9mm	Transparent	450pcs	<input type="checkbox"/>	<input type="checkbox"/>

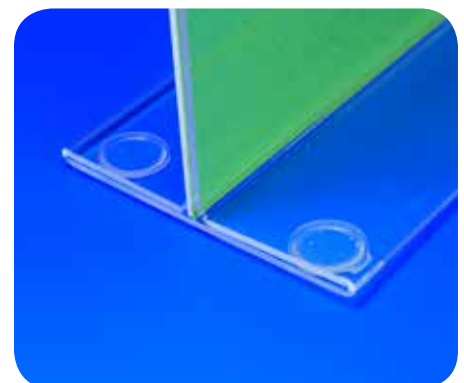
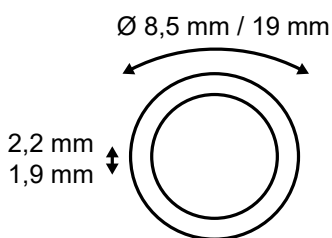

6.5 Adhesive tapes

Adhesive tapes are used in a variety of industries for general packaging and product assembly and are the latest in non-mess gluing and fastening. They increase productivity as the bond is instant and eliminate the need for expensive machinery.

FOA3

Double-sided "Easy Peel" permanent acrylic adhesive foam tape.

→ Supplied in 50m rolls.

	L (ROLL)	W	THICKNESS	ADHESIVE	COLOR	<input checked="" type="checkbox"/>	
FOA3/8	50m	8mm	1mm	Foam Permanent	White	●	
FOA3/18	50m	18mm	1mm	Foam Permanent	White	●	
FOA3/25/B	50m	25mm	1mm	Foam Permanent	White	●	

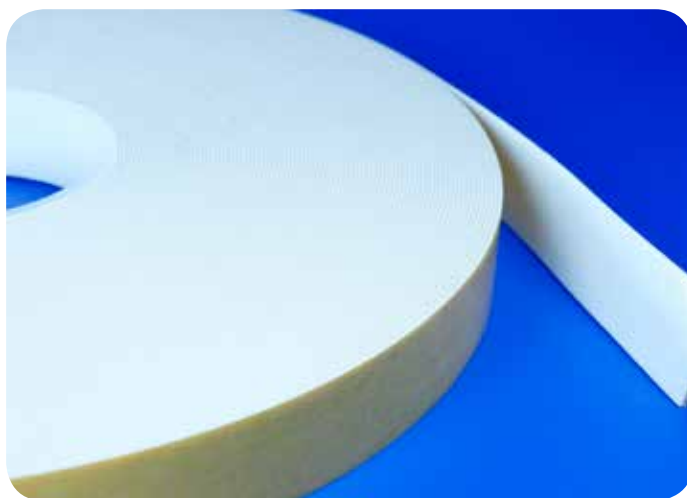
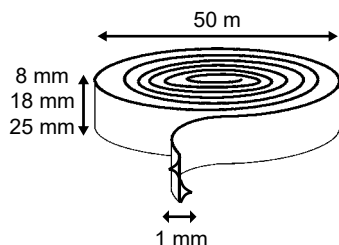

FOA5

Double-sided "Easy Peel" removable acrylic adhesive foam tape.

→ Supplied in 33m rolls.

	L (ROLL)	W	THICKNESS	ADHESIVE	COLOR	<input checked="" type="checkbox"/>	
FOA5/12	33m	12mm	1mm	Acryl Removable	Transparent	●	
FOA5/19	33m	19mm	1mm	Acryl Removable	Transparent	●	

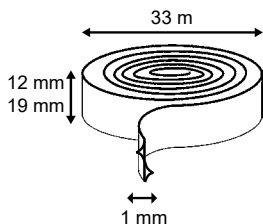

FOA6

Double-sided "Easy Peel" removable black acrylic foam tape. Suitable for outdoor use and UV-resistant.

→ Supplied in 25m rolls.

	L (ROLL)	W	THICKNESS	ADHESIVE	COLOR	<input checked="" type="checkbox"/>	
FOA6/12	25m	12mm	1mm	Foam Removable	Black	<input type="checkbox"/>	<input checked="" type="checkbox"/>
FOA6/19	25m	19mm	1mm	Foam Removable	Black	<input checked="" type="checkbox"/>	<input type="checkbox"/>

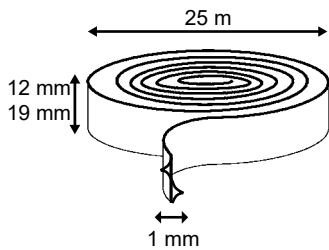

FOA7

Double-sided "Easy Peel" permanent acrylic adhesive tape.

→ Supplied in 500m rolls.

	L (ROLL)	W	THICKNESS	ADHESIVE	COLOR	<input checked="" type="checkbox"/>	
FOA7/9	500m	9mm	1mm	Acryl Permanent	Transparent	<input checked="" type="checkbox"/>	<input type="checkbox"/>
FOA7/13	500m	13mm	1mm	Acryl Permanent	Transparent	<input checked="" type="checkbox"/>	<input type="checkbox"/>

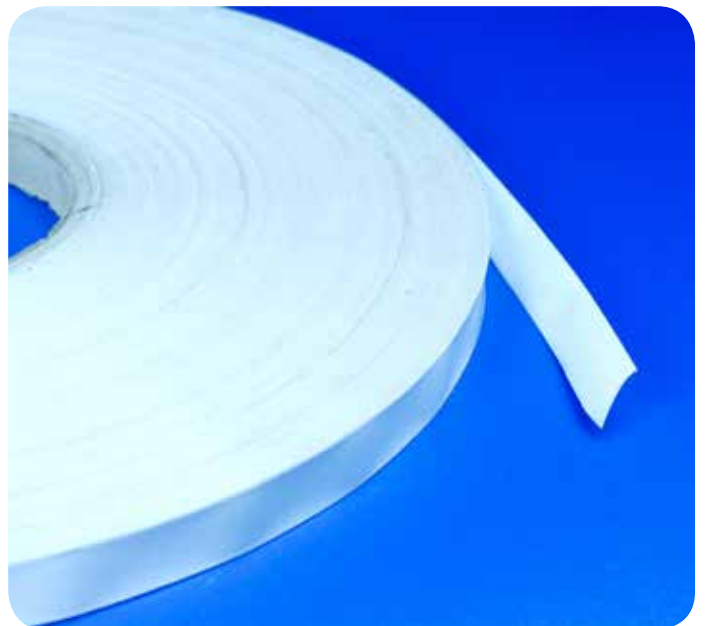
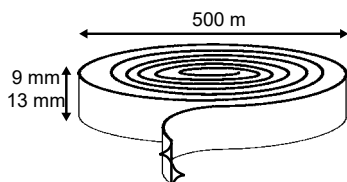

FOA12/12 – FOA13

Double-sided permanent adhesive transfer tape. To be used with the hand-held tape dispenser (FOA13).

→ Supplied in 33m rolls.

	L (ROLL)	W	THICKNESS	ADHESIVE	COLOR	<input checked="" type="checkbox"/>	
FOA12/12	33m	12mm	1mm	Transfer tape Permanent	Transparent	•	
FOA13	ATG 700 System : to use with reference FOA12/12					•	



FOA15

Double-sided removable tape dispenser.

	L (ROLL)	W	ADHESION	COLOR	<input checked="" type="checkbox"/>	
FOA15	12m	8mm	Removable	Transparent	•	



6

6.6 Glue dots

Our SuperDots are a great way to stick items together – or to hold things in place in packaging. Colorless, quick and easy to use, they dispense a standard dot of glue without getting your fingers messy or adhesive residues. A little glue dot with a lot of power.

DOT3

Double-sided adhesive glue dots, available in different strengths.

→ Supplied on rolls.

	Ø	ADHESION	COLOR	QUANTITY	<input checked="" type="checkbox"/>	
DOT3/ET	10mm	Easy Tak <i>Removable</i>	Transparent	5000pcs	<input type="checkbox"/>	
DOT3/MT	10mm	Mid Tak <i>Semi-Permanent</i>	Transparent	5000pcs	<input type="checkbox"/>	
DOT3/UT	10mm	Ultra Tak <i>Permanent</i>	Transparent	5000pcs	<input type="checkbox"/>	
DOT3/ATG	10mm	Mid Tak <i>Semi-Permanent</i>	Transparent	1500pcs	<input type="checkbox"/>	

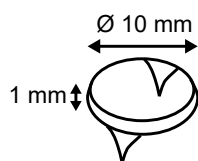

6.7 Magnetic discs

Magnetic discs are designed to hold boxes, folders and acrylic panels. Ideal for hidden closures or fixing applications. A very strong and positive pull force.

MAG12

Self-adhesive round magnetic discs with 3M backing (matching poles).

→ Supplied on straps.

	Ø	THICKNESS	QUANTITY	<input checked="" type="checkbox"/>	
MAG12	9.5mm	0.75mm	50 sets	<input type="checkbox"/>	

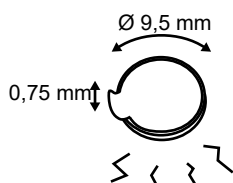

6.8 Magnetic tapes

Self-adhesive magnetic tape is designed to provide a strong grip on different surfaces. It offers a cost effective solution for all your display needs.

MAG5

Self-adhesive magnetic tape.

→ Supplied on rolls.

→ Custom lengths supplied on request.

	L (ROLL)	W	THICKNESS	<input checked="" type="checkbox"/>	
MAG5/1.0/10	10m	10mm	1mm	●	
MAG5/1.0/20	10m	20mm	1mm	●	
MAG5/1.0/30	10m	30mm	1mm		●
MAG5/1.0/50	10m	50mm	1mm		●
MAG5/1.5/20	10m	19mm	1.5mm	●	

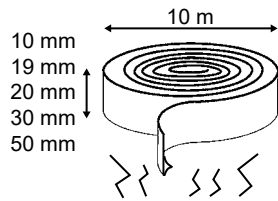

MAG5/MP

Self-adhesive magnetic tape with matching poles.

→ Positive and negative rolls are sold separately.

→ Supplied on rolls.

	L (ROLL)	W	THICKNESS	POLE	<input checked="" type="checkbox"/>	
MAG5/MP	30m	12.7mm	1.5mm	+	●	
MAG5/MPMIN	30m	12.7mm	1.5mm	-	●	

(Positive roll is with the line on the adhesive backing)

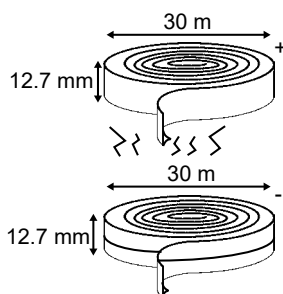

L → length | W → width | H → height | Ø → diameter |  → capacity | → stock |  → on request

MAG13

White coated, galvanized, adhesive backed steel tape. The steel tape can turn all your surfaces into magnetically attractive ones.
 → Supplied on rolls.

	L (ROLL)	W	THICKNESS	<input checked="" type="checkbox"/>	
MAG13	30m	12.5mm	0.11mm	<input type="checkbox"/>	
MAG13/19*	30m	19mm	0.11mm	<input type="checkbox"/>	<input type="checkbox"/>

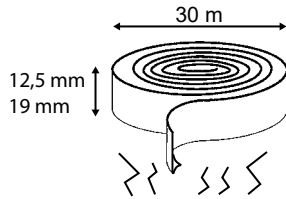

MAG/CLIP

Magnetic graphic clip holder in white with an adhesive back. The clip holder can be used on walls, windows or metal surfaces. It is easy to install and can be supplied with an adhesive or magnetic back.
 → The clip holder has a length of 210mm.
 → Custom colors, printing or lengths supplied on request.

	L	W	ADHESIVE	COLOR	<input checked="" type="checkbox"/>	
MAG/CLIP	210mm	24mm	Foam Permanent	White	<input type="checkbox"/>	

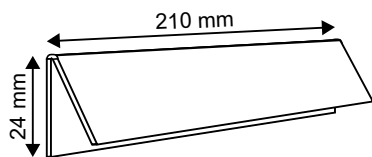

L → length | W → width | H → height | Ø → diameter |  → capacity | → stock |  → on request

6.9 File prongs & accessories

A range of filing accessories that can be used as a complimentary range to the display accessories range.

DOC1

File prong in white metal with an adhesive backing.
 → Can be mounted on request with our reference DOC3.



	L	W	COLOR	<input checked="" type="checkbox"/>	
DOC1	150mm	9mm	White	•	

DOC2

File prong in metal, available in white covered PVC or brass plated.

	L	W	COLOR	<input checked="" type="checkbox"/>	
DOC2/M	165mm	4.5mm	White	•	
DOC2/PVC	165mm	4.5mm	Brass	•	

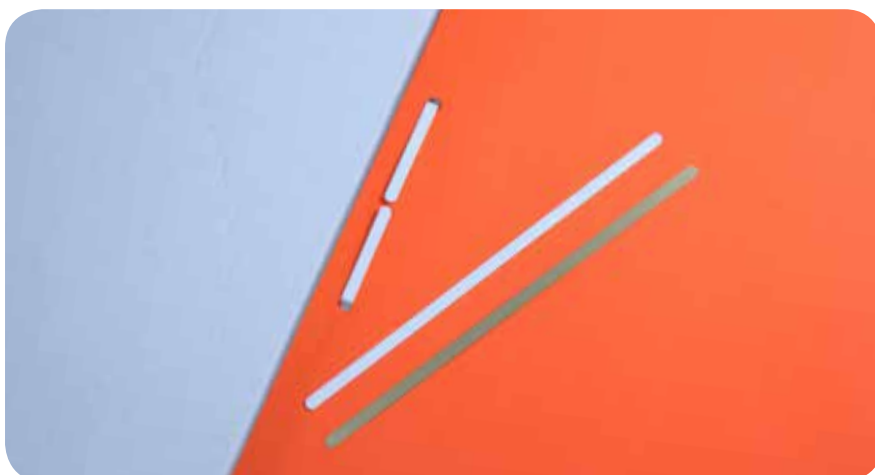

DOC3

File cover plate in white PVC or brass plated metal.
 → Can be mounted on request with our reference DOC1.

	L	W	COLOR	<input checked="" type="checkbox"/>	
DOC3/PVC	95mm	12mm	White	•	
DOC3/M	95mm	12mm	Brass		•



6.10 CD accessories

Packaging for CD's and DVD's is available in the form of CD pockets, CD dots or CD Centres if you are looking to protect or attach your CD's onto any packaging. See below as we have a range of self adhesive foam dots that are a budget alternative that will hold a CD or disc in place.

POC5 - POC6

Self-adhesive CD pocket in transparent PVC.

	L	W	OPENING	<input checked="" type="checkbox"/>	
POC5	127mm	127mm	Dumb recess	•	
POC6	126mm	127mm	Flap + adhesive dot	•	

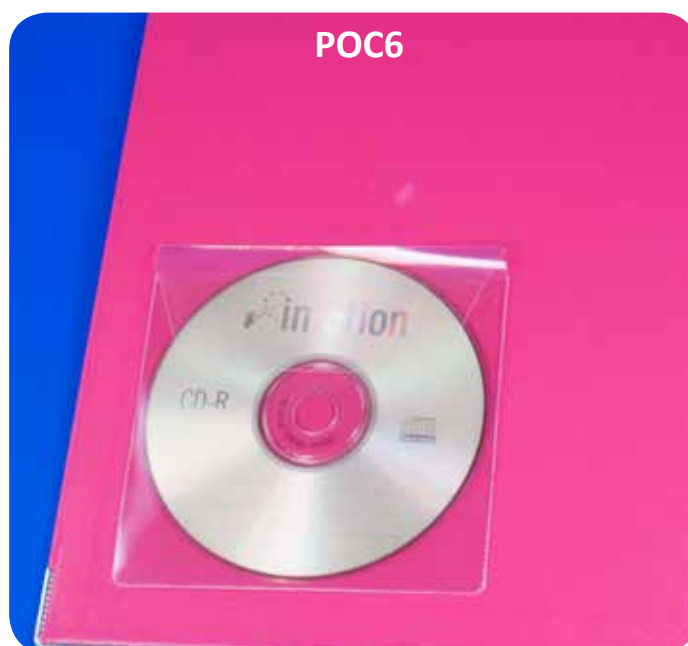

POC8

Self-adhesive USB pocket in transparent PVC with a flap and adhesive dot.

	L	W	OPENING	<input checked="" type="checkbox"/>	
POC8	52.5mm	90mm	Flap + adhesive dot	•	

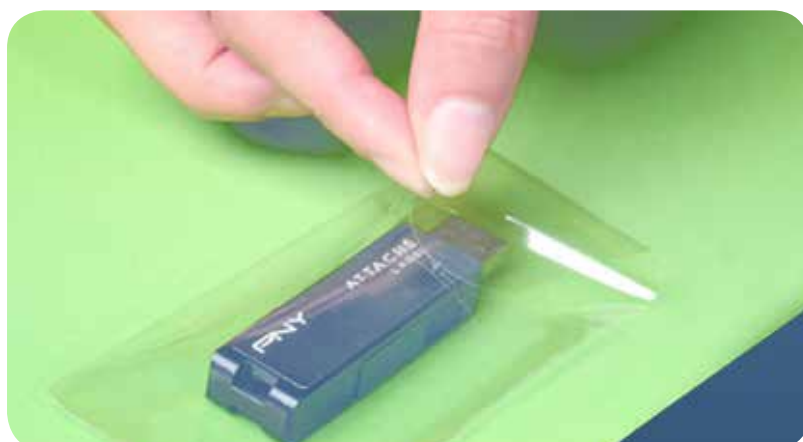

CDP

Self-adhesive CD foam studs.

→ Supplied on sheets.

	Ø	THICKNESS	COLOR	STUDS/SHEET	<input checked="" type="checkbox"/>	
CDP	16mm	3.5mm	White	1000pcs	•	
CDPZW	16mm	3.5mm	Black	1000pcs	•	

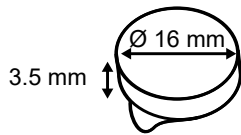

CDR

Self-adhesive CD holder in plastic.

→ Supplied in bags.

	Ø	THICKNESS	COLOR	QUANTITY	<input checked="" type="checkbox"/>	
CDR/R	35mm	3.9mm	White	1000pcs	•	
CDR/RT	35mm	3.9mm	Transparent	1000pcs	•	
CDR/RZ	35mm	3.9mm	Black	1000pcs	•	

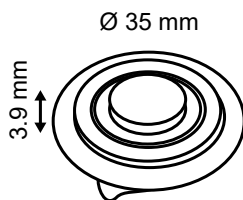

6.11 Ball chains & accessories

An exhaustive range of chains, links, connectors and its fasteners to hang posters or media at the point of sale.

CHA

Ball chains on reels or cut-to-length with connector included.
 → Custom lengths or colors supplied on request.

	L	∅	COLOR	<input checked="" type="checkbox"/>	
CHA1H/10	100mm	2.4mm	Chrome	●	
CHA1H/15	150mm	2.4mm	Chrome	●	
CHA1H/22	220mm	2.4mm	Chrome	●	
CHA1H/30	300mm	2.4mm	Chrome	●	
CHA1H	25m/roll	2.4mm	Chrome	●	
CHA2H	25m/roll	3.2mm	Chrome	●	



CHA3H

Ball chain connector.
 → Custom colors supplied on request.

	L	∅	COLOR	<input checked="" type="checkbox"/>	
CHA3H/2.4	8mm	2.4mm	Chrome	●	
CHA3H/3.6	11mm	3.6mm	Chrome	●	



CHA4

Ball chain fastener.

	L	W	∅	COLOR	<input checked="" type="checkbox"/>	
CHA4/2.5	8mm	5mm	2.5mm	Chrome	●	
CHA4/3.6	12mm	7mm	3.6mm	Chrome	●	



CHA9

Split ring in metal, ideal for hanging or connecting POS items.

	∅	COLOR	<input checked="" type="checkbox"/>	
CHA9	20mm	Chrome	●	

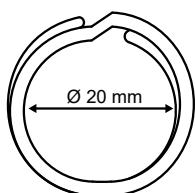

6.12 Rings & hooks

A variety of plastic or metal hooks and rings provide numerous display opportunities, including linking signs together, securing signs and tickets to wire baskets and to hold simple cards.

H003

Hook with a crimped end to hang up hang strips.

	L	W HOOK	THICKNESS	COLOR	<input checked="" type="checkbox"/>	
H003	39mm	18mm	2mm	Chrome	•	

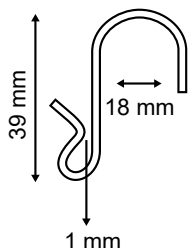

H0017

Hook with a crimped end to hang up hang strips.

	L	W HOOK	THICKNESS	COLOR	<input checked="" type="checkbox"/>	
H0017	45mm	22mm	2.5mm	Chrome	•	

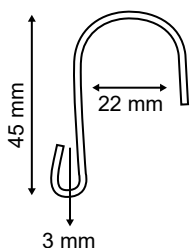

H0018

Hook with a crimped end to hang up hang strips.

	L	W HOOK	THICKNESS	COLOR	<input checked="" type="checkbox"/>	
H0018	45mm	22mm	2.5mm	Chrome	•	

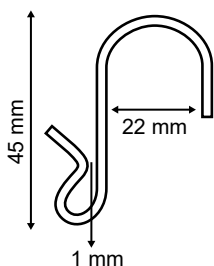

HOO20N

Hook with a crimped end to hang up hang strips.

	L	W HOOK	THICKNESS	COLOR	<input checked="" type="checkbox"/>	
HOO20N	49mm	15mm	4mm	White Nylon	•	

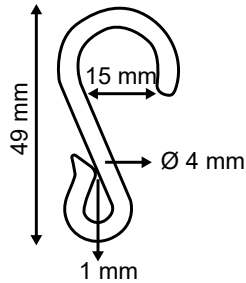

HOO10

Metal shelf-top hook to hang hang-strips in flag position.

	L	CENTER HOLE	∅	COLOR	<input checked="" type="checkbox"/>	
HOO10	100mm	30mm	3mm	Chrome	•	

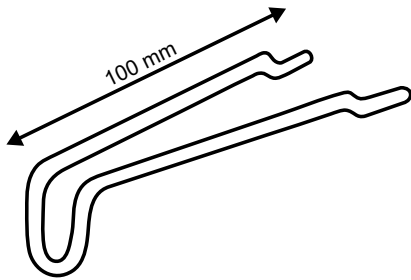

HOO4 - HOO5J

Metal S-hook.

	L	W HOOK	THICKNESS	<input checked="" type="checkbox"/>	
HOO4	26mm	8mm	2.1mm	•	
HOO5J	65mm	22mm	2.5mm	•	

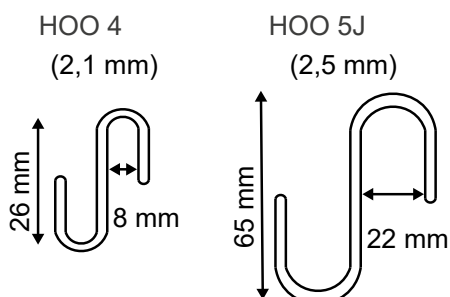

HOO9/B – HOO16/60

Metal C-hook.

	L	W HOOK	THICKNESS	<input checked="" type="checkbox"/>	
HOO9/B	39mm	10mm	2mm	•	
HOO16/60	60mm	20mm	2mm	•	

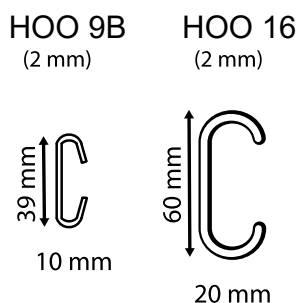

HOO11

Oval pop-ring in white polypropylene.

	H	W	THICKNESS	COLOR	<input checked="" type="checkbox"/>	
HOO11	30mm	18mm	2.4mm	White	•	

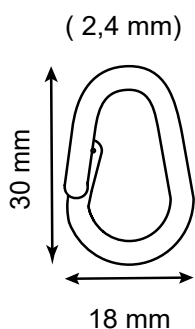

6

HOO13

Round pop-ring in white polypropylene.

	∅	THICKNESS	COLOR	<input checked="" type="checkbox"/>	
HOO13	15mm	2.7mm	White	•	

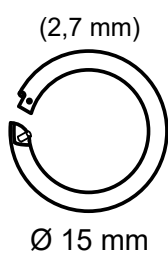

H0014

Metal locking ring.

	∅	THICKNESS	COLOR	☑	🛒
H0014/14	14mm	2.3mm	Chrome	•	
H0014/19	19mm	2.3mm	Chrome	•	
H0014/25	25mm	2.7mm	Chrome	•	
H0014/32	32mm	3.2mm	Chrome	•	
H0014/38	38mm	3.3mm	Chrome	•	
H0014/50	50mm	3.4mm	Chrome	•	
H0014/60	60mm	3.5mm	Chrome	•	
H0014/76	76mm	4.5mm	Chrome	•	
H0014/80	80mm	4.8mm	Chrome		•

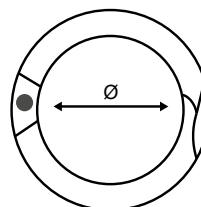

H0021

Metal display sampling ring.

→ Diameter: 152mm

→ Other diameters supplied on request.

	∅	COLOR	☑	🛒
H0021	152mm	Chrome	•	

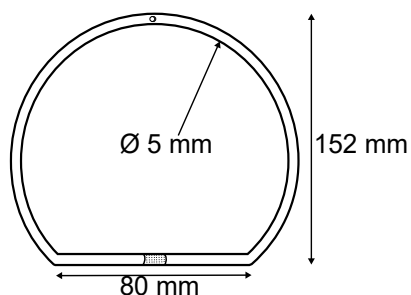

H0015/35

Metal pear clip.

	H	W HOOK	THICKNESS	COLOR	☑	🛒
H0015/35	66mm	35mm	2mm	Chrome	•	

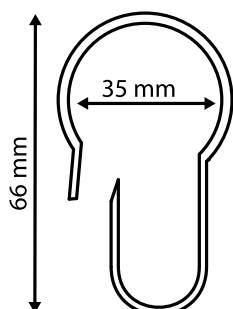

FOT4

Self-adhesive poster hanger to stick on the back of posters or calendars.

L	H	COLOR	<input checked="" type="checkbox"/>	
30mm	24mm	White	•	

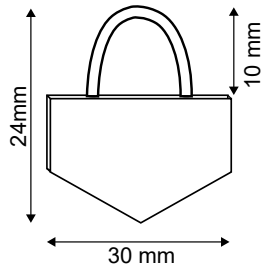

FOT5/40

Self-adhesive photo hook in white plastic with a metal triangle.

∅	COLOR	<input checked="" type="checkbox"/>	
40mm	White	•	

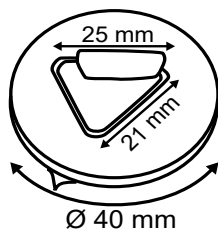

L → length | W → width | H → height | ∅ → diameter |  → capacity | → stock |  → on request

7. Frames

You like to think big and you want to blow your clients from their feet or convince them to come in? Then have a look at our extensive range of frames, memo boards, information and floor stands. All made of sustainable materials and very easy to use. In this way, you only use one information board to present different campaigns year after year.

Curious? Have a look in our showroom and mainly amaze yourself.

7.1 Snap frames

7.2 Frame boards

7.3 Show card stand

7.4 Plastic frames and accessories

7.5 Pavement signs

7.6 Banner Displays



7.1 Snap frames

Show card stands are very useful in different ways: to stand outside a restaurant displaying menus, to direct guests to a specific location within a venue or building, to draw customers' attention to a specific product or advertise an in-store upcoming event.

KAD1

Aluminum snap frame with square corners, provided with an anti-reflective PET cover. Each frame includes wall mounting accessories.

→ Other colors and sizes upon request.



	SIZE	W PROFILE	☑	🛒
KAD1/A1	A1	20mm		●
KAD1/A2	A2	20mm		●
KAD1/A3	A3	20mm	●	
KAD1/A4	A4	20mm	●	
KAD1/A5	A5	20mm	●	
KAD1/A6	A6	20mm		●
KAD1/25/50x70	500 x 700mm	25mm	●	
KAD1/25/60x80	600 x 800mm	25mm	●	
KAD1/25/70x100	700 x 1000mm	25mm	●	
KAD1/25/A1	A1	25mm	●	
KAD1/25/A2	A2	25mm	●	
KAD1/A3/25	A3	25mm	●	
KAD1/A4/25	A4	25mm		●
KAD1/32/50x70	500 x 700mm	32mm	●	
KAD1/32/70x100	700 x 1000mm	32mm	●	
KAD1/32/A0	A0	32mm	●	
KAD1/32/A1	A1	32mm	●	
KAD1/32/A2	A2	32mm	●	

→ Snap frame with LED can be supplied on request (KAD1/LIG).



KAD10

Aluminum snap frame with round corners. Hanging or counter support.

→ Provided with an anti-reflective PET cover.



	SIZE	PROFILE	✓	🛒
KAD10/25/A3R	A3	25mm	●	
KAD10/25/A4R	A4	25mm	●	



KAD1L

Aluminum snap frame with square corners, lockable by key.

→ Provided with an anti-reflective PET cover.

→ Each frame includes wall fixing accessories.



	SIZE	PROFILE	✓	🛒
KAD1L/50x70	500 x 700mm	32mm	●	
KAD1L/70x100	700 x 1000mm	32mm		●
KAD1L/A0	A0	32mm		●
KAD1L/A1	A1	32mm	●	
KAD1L/A2	A2	32mm		●
KAD1L/A3	A3	32mm	●	



L → length | W → width | H → height | Ø → diameter | → capacity | → stock | → on request

KAD1/W

Double-sided aluminum snap frame with square corners, provided with an anti-reflective PET cover. Can be suspended from the ceiling via wire cables in portrait or landscape position.

→ Each frame includes hanging hooks for suspension.

	SIZE	PROFILE	<input checked="" type="checkbox"/>	
KAD1/W/50x70	500 x 700mm	25mm	<input checked="" type="checkbox"/>	•
KAD1/W/70x100	700 x 1000mm	25mm	<input checked="" type="checkbox"/>	•
KAD1/W/A1	A1	25mm	<input checked="" type="checkbox"/>	•
KAD1/W/A2	A2	25mm	<input type="checkbox"/>	•
KAD1/W/A3	A3	25mm	<input checked="" type="checkbox"/>	•
KAD1/W/A4	A4	25mm	<input type="checkbox"/>	•



KAD1/WT

Double-sided aluminum self-adhesive window snap frame with square corners. The system includes decorative back profile to hide the double-sided adhesive tape which holds the frame to the window.

→ Not UV-resistant.

→ Supplied with 2 transparent anti-reflective PET covers.

	SIZE	PROFILE	<input checked="" type="checkbox"/>	
KAD1/WT/50x70	500 X 700mm	32mm	<input type="checkbox"/>	•
KAD1/WT/70x100	700 x 1000mm	32mm	<input type="checkbox"/>	•
KAD1/WT/A0	A0	32mm	<input checked="" type="checkbox"/>	•
KAD1/WT/A1	A1	32mm	<input type="checkbox"/>	•
KAD1/WT/A2	A2	32mm	<input type="checkbox"/>	•
KAD1/WT/A3	A3	32mm	<input type="checkbox"/>	•
KAD1/WT/A4	A4	32mm	<input type="checkbox"/>	•



L → length | W → width | H → height | Ø → diameter | → capacity | → stock | → on request

KAD1/PU

Double-sided aluminum slide-in frame with adhesive tape on the bottom feet. This product is delivered in landscape position.

→ Provided with an anti-reflective PET cover.

→ 100 % WATERPOOF.



	SIZE	PROFILE	<input checked="" type="checkbox"/>	
KAD1/PU/A3	A3	25mm	<input checked="" type="checkbox"/>	
KAD1/PU/A4	A4	25mm	<input checked="" type="checkbox"/>	
KAD1/PU/A5H	A5	25mm		<input checked="" type="checkbox"/>

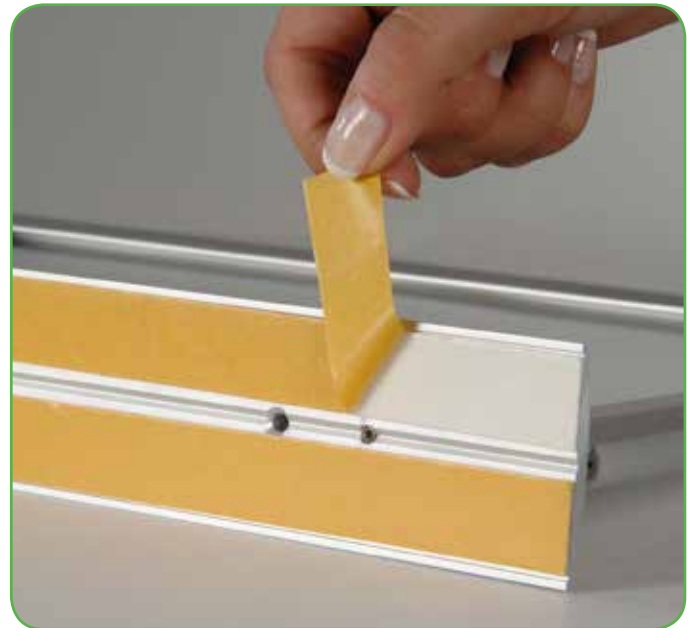

Standard & Specific Sizes

Besides our standard stock items, you may need a custom made aluminium frame dimension.

We can then manufacture the exact requested size upon request for you.

Please find below the commonly used standard dimensions:

A1: 841mm H X 594mm W

A2: 594mm H X 420mm W

A3: 420mm H X 297mm W

A4: 297mm H x 210mm W

A5: 210mm H x 148mm W

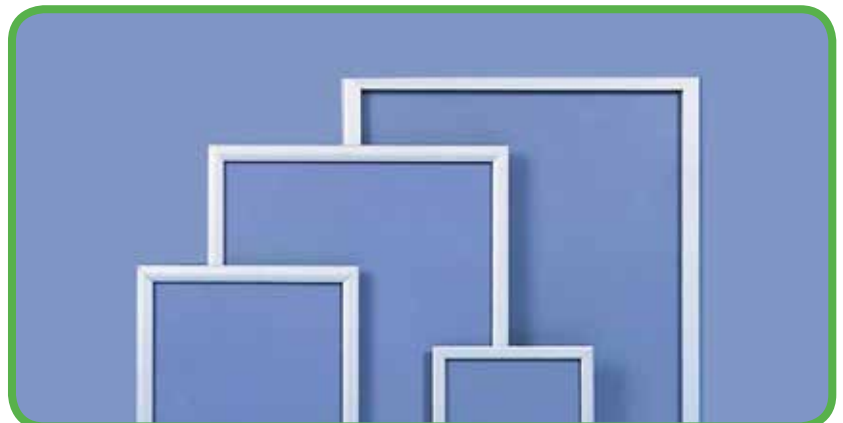

7

7.2 Frame boards

Our frame boards are manufactured with aluminum using high precision framing techniques for quality finished products. This allows to display practical and decorative message boards for any use: drawings, grades, notes, agendas, to do lists, general information, photographs, reminders, messages and more can be displayed in a classy and professional manner.

MEM1

Aluminum lockable memo board with square corners. Each product includes 1 key set, screws and plugs.

→ Suitable for outdoor use.

→ Only available on request.

	SIZE	PROFILE	✓	🛒
MEM1/50x70	500 X 700mm	45mm		•
MEM1/70x100	700 x 1000mm	45mm		•
MEM1/A0	A0	45mm		•
MEM1/A1	A1	45mm		•
MEM1/A2	A2	45mm		•
MEM1/A3	A3	45mm		•

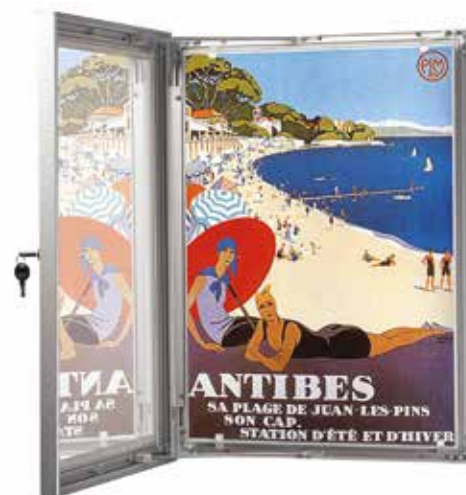

MEM2

Aluminum lockable memo board with square corners. Can be used in portrait or landscape positions. Each board includes wall mounting accessories and a free set of magnets.

→ Suitable for outdoor use.

→ Only available on request.

	SIZE	PROFILE	✓	🛒
MEM2/12A4	12 x A4	50mm		•
MEM2/4A4	4 x A4	50mm		•
MEM2/6A4	6 x A4	50mm		•
MEM2/9A4	9 x A4	50mm		•



MEM3

White magnetic glass board. Each board comes with magnets, pen holder, eraser and pen.

	SIZE	COLOR	✓	🛒
MEM3/45x45	450 X 450mm	White	•	
MEM3/60x90	600 x 900mm	White	•	
MEM3/35x35	350 x 350mm	White/Red/Black		•
MEM3/40x60	400 x 600mm	White/Red/Black		•



7.3 Show card stand

Show card stands are very useful in different ways: to stand outside a restaurant displaying menus, to direct guests to a specific location within a venue or building, to draw customers' attention to a specific product or advertise an in-store upcoming event.

KAD10

Show card stand with aluminum snap frame with square corners. The show card stand can be used in portrait or landscape positions.

→ Provided with an anti-reflective PET cover.

	SIZE POSTER	TOTAL HEIGHT	SIZE FOOT	<input checked="" type="checkbox"/>	
KAD10/A3	A3	1200mm	320x430mm	●	
KAD10/A4	A4	850mm	250x330mm	●	



KAD14

Curved black menu board with 2 positions as portrait or landscape.

→ Provided with an anti-reflective PET cover.

	SIZE POSTER	TOTAL HEIGHT	Ø FOOT	COLORS	<input checked="" type="checkbox"/>	
KAD14/A3	A3 Portrait	1262mm	358mm	Black	●	
KAD14/A4	A4 Portrait	1212mm	358mm	Black	●	
KAD14/A3	A3 Landscape	1212mm	358mm	Silver		●
KAD14/A4	A4 Landscape	1176mm	358mm	Silver		●



KAD10/TAB

Universal curved kiosk for tablets with a black cover on top. Rotatable to display landscape or portrait positions. Suitable for iPad, Samsung Galaxy and 9.7" - 10.1" tablets.

→ Cables are sold separately.

	SIZE	TOTAL HEIGHT	Ø FOOT	<input checked="" type="checkbox"/>	
KAD10/TAB	290x222mm	1181mm	358mm	●	



KAD18

Double-sided black information floor stand, with 2 anti-reflective PET covers and 1 black PVC cover. The black PVC cover is used in the middle to prevent light transmission.

→ Self-assembly.

	SIZE POSTER	TOTAL HEIGHT	SIZE FOOT	<input checked="" type="checkbox"/>	
KAD18	A1	1595mm	656x380mm	●	
KAD18/50x70	500x700mm	1595mm	562x380mm		●



KAD19

Clear acrylic lockable box.

→ Color white and printing on the walls on request.

	L	H	W	SLOT	CLOSE FLAP	<input checked="" type="checkbox"/>	
KAD19	240mm	250mm	240mm	125mm	120 x 140mm	•	

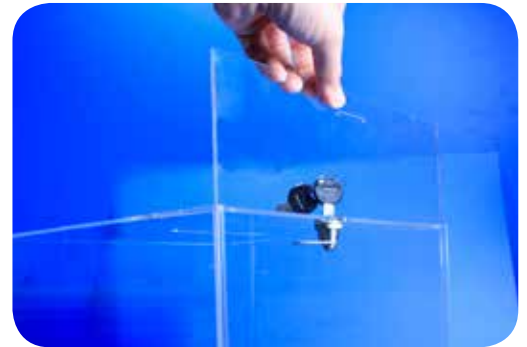

FRA6

Magnetic swing frame in white (excluding PVC pocket).

→ Other colors and sizes supplied on request.

	SIZE	COLOR	<input checked="" type="checkbox"/>	
FRA6/A5	A5	White	•	
FRA6/A6	A6	White	•	



FRA/MAG

Magnetic window in black.

→ Other colors and sizes supplied on request.

	SIZE	COLOR	<input checked="" type="checkbox"/>	
FRA/MAG/A3	A3	Black	•	
FRA/MAG/A4	A4	Black	•	
FRA/MAG/A5	A5	Black	•	



L → length | W → width | H → height | Ø → diameter |  → capacity | → stock |  → on request

7.4 Plastic frames & accessories

Plastic frames and its accessories range can be placed almost everywhere in the retail & shops, when promoting, selling or displaying important information about your products and services. The range of products that can be advertised is endless and the media in the double sided frame can be changed whenever you wish.

Plastic show card frames are no longer being carried in stock as a standard product of our range. If need be, we can however source them any time within a reasonable time frame.



FRA1H/C

Transparent anti-reflective PVC-cover

	SIZE	COLORS	<input checked="" type="checkbox"/>	
FRA1H/C-A3	A3	Transparent	<input type="checkbox"/>	•
FRA1H/C-A4	A4	Transparent	•	
FRA1H/C-A5	A5	Transparent		•



7.5 Pavement signs

Pavement signs are very effective for high street advertising: they can help you attract new customers into your organization or promote a special offer you are running. There are many different types of pavement signs available, browse below to find the best option for your business or organization.

KAD3W

Aluminum double-sided A-pavement sign board with snap frame and square corners. Each sign board includes an anti-reflective PET cover. Suitable for outdoor use but not waterproof.

	SIZE POSTER	PROFILE	TOTAL HEIGHT	<input checked="" type="checkbox"/>	
KAD3W/50x70	500x700mm	32mm	1450mm	•	
KAD3W/70x100	700x1000mm	32mm	1050mm	•	
KAD3W/A0	A0	32mm	950mm	•	
KAD3W/A1	A1	32mm	1200mm	•	

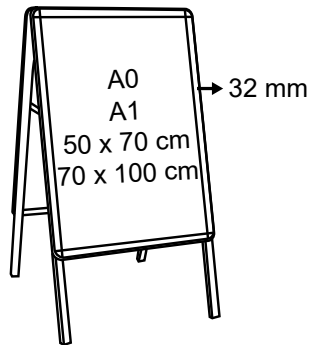

KAD3/P

Double-sided water base pavement sign. Base can be filled with water or sand.
→ 100% WATERPROOF. Maximum water capacity is 5 liters.

	SIZE POSTER	TOTAL HEIGHT	CAPACITY	<input checked="" type="checkbox"/>	
KAD3/P	325x570mm	755mm	Max. 5L	•	

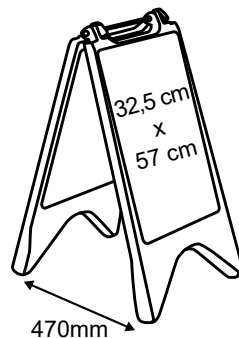

KAD3/M

Double-sided magnetic A-sidewalk board with square corners. Each board is delivered with a magnetic cover placed over the poster.
 → 100% WATERPROOF. Only supplied on request.

	SIZE POSTER	TOTAL HEIGHT	<input checked="" type="checkbox"/>	
KAD3/M/50x70	500x700mm	1230mm		•
KAD3/M/70x100	700x1000mm	1425mm		•
KAD3/M/A1	A1	1230mm		•

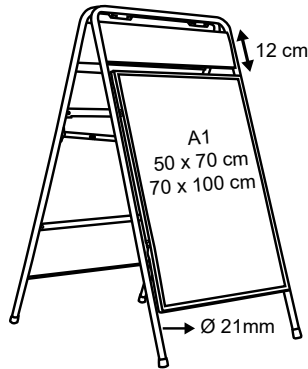

KAD5NW

Aluminum double-sided sidewalk board with snap frame and square corners.
 The board has steel springs for flexibility and an anti-reflective PET cover. Suitable for outdoor use. Self-assembly.

	SIZE POSTER	PROFILE	TOTAL HEIGHT	<input checked="" type="checkbox"/>	
KAD5NW/50x70	500x700mm	32mm	1070mm		•
KAD5NW/70x100	700x1000mm	32mm	1370mm	•	
KAD5NW/A0	A0	32mm	1560mm	•	
KAD5NW/A1	A1	32mm	1210mm	•	

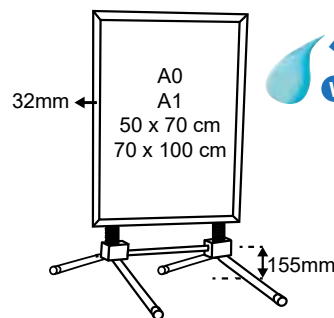

L → length | W → width | H → height | Ø → diameter | → capacity | → stock | → on request

KAD9W

Double-sided pavement sign on wheels with snap frame and square corners. It can be easily filled with water or sand, has steel springs for flexibility and includes an anti-reflective PET cover. 100% WATERPROOF. Self-assembly.

	SIZE POSTER	PROFILE	TOTAL HEIGHT	<input checked="" type="checkbox"/>	
KAD9W/50x70	500x700mm	45mm	1020mm	•	
KAD9W/70x100	700x1000mm	45mm	1320mm	•	
KAD9W/A0	A0	45mm	1510mm	•	
KAD9W/A1	A1	45mm	1165mm	•	

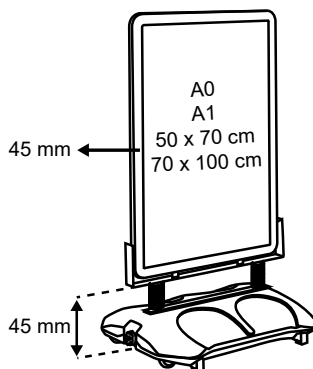

KAD25

Aluminum sidewalk board on wheels with a magnetic edged poster wallet and a plastic black base. It can be easily filled with water or sand and includes an anti-reflective PET cover.

→ NOT WATERPROOF.

	SIZE POSTER	TOTAL HEIGHT	<input checked="" type="checkbox"/>	
KAD25	500x700mm	1104mm	•	

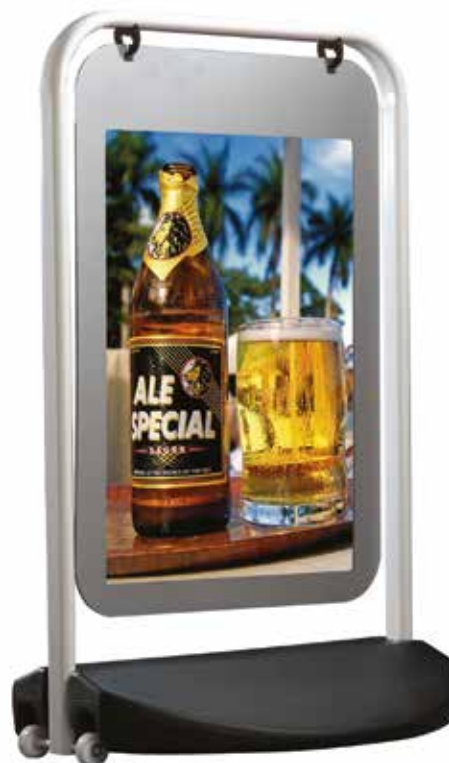
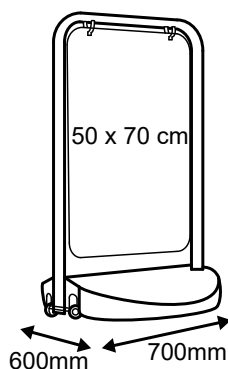

KAD16

Simple plastic pavement sign in black. Suitable to write on with water base chalk pens.

	SIZE BOARD	TOTAL HEIGHT	<input checked="" type="checkbox"/>	
KAD16	480x815mm	880mm	•	

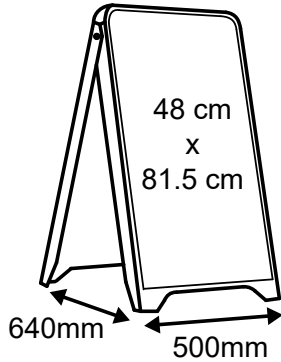

KAD17

Wooden double-sided "A" chalk board. Chalk markers are sold separately (KAD20).

	SIZE BOARD	TOTAL HEIGHT	<input checked="" type="checkbox"/>	
KAD17	600x800mm	1050mm	•	

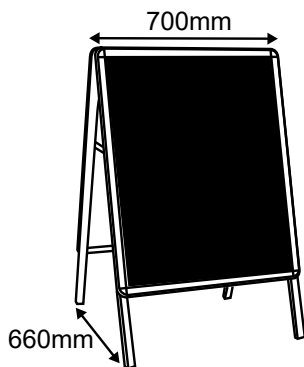

KAD20



7.6 Banner Displays

Banner stands are the perfect display solution to advertise your product, business or message on trade shows, exhibitions, shopping centers, special events, retail environments or any other venues.

BAN8

Aluminum roll-up banner display with poster clamp and adhesive on the bottom. Carrier bag included.

	SIZE POSTER	<input checked="" type="checkbox"/>	
BAN8	850 x 2000mm	•	
BAN8/100	1000 x 2000mm	•	



BAN20/80

Steel poster trap. Poster thickness is adjustable by screwing the 2 parts. For all indoor use.

	L	W	H	Ø HOLE	COLORS	<input checked="" type="checkbox"/>	
BAN20/80	800mm	200mm	140mm	9mm	Steel	•	

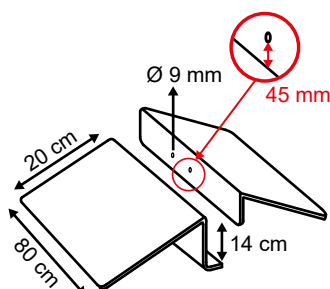

L → length | W → width | H → height | Ø → diameter |  → capacity | → stock |  → on request

8. Miscellaneous

Besides our big product categories we also propose a number of individual products in our range. We offer for example anti-theft systems and handles to transport big boxes in an easier way.

Finally we proudly present one of our bestsellers: date indicators for your personalized annual calendars. Still didn't find what you are looking for? Everything is possible. Contact us and discover what we can do for your clients.

8.1 Security systems

8.2 Handles

8.3 Calendar accessories



8.1 Security systems

A range of retail security accessories to prevent theft of higher value items or more desirable products: mobile phones, video cameras, computer accessories, etc

SAF1

Grey plastic extending safety coil with metal split-ring on either end.

SAF2

Grey plastic extending safety coil with metal split-ring and adhesive disc on one end.

SAF3 – SAF3/W

Grey or white plastic extending safety coil with metal split-ring on one end and an adhesive disc on the other end.

	L	RING Ø	COLORS	<input checked="" type="checkbox"/>	
SAF1	Extendable 120mm to 800mm	20mm	Grey	•	
SAF2	Extendable 120mm to 800mm	20mm + 2 adhesive buttons (20x20mm)	Grey	•	
SAF3	Extendable 120mm to 800mm	20mm + 1 adhesive buttons (20x20mm)	Grey	•	
SAF3/W	Extendable 120mm to 800mm	20mm + 1 adhesive button (20x20mm)	White	•	

SAF1



SAF2



SAF3 - SAF3/W

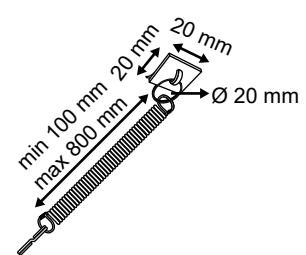
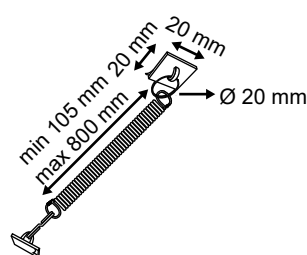
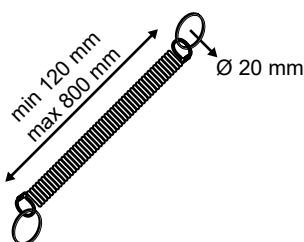

L → length | W → width | H → height | Ø → diameter |  → capacity | → stock |  → on request

PUL2H/L

Black plastic adhesive pull-box (anti-theft) with retractable coated steel cable with a loop at one end.

PUL2H

Black plastic adhesive pull-box (anti-theft) with adhesive plate at the end of the retractable coated steel cable.

→ Supplied on request with 3M tape.

	L	W	CABLE	CABLE END	<input checked="" type="checkbox"/>	
PUL2H/L	33mm	50mm	∅: 0.75 mm Extension to 1 m	Loop	•	
PUL2H	33mm	50mm	∅: 0.75 mm Extension to 0.95 m	Plate: 19 x 45mm	•	

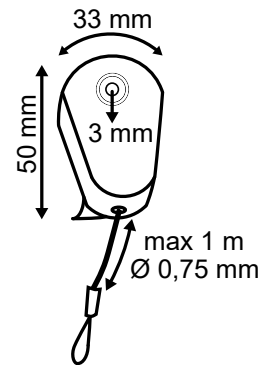
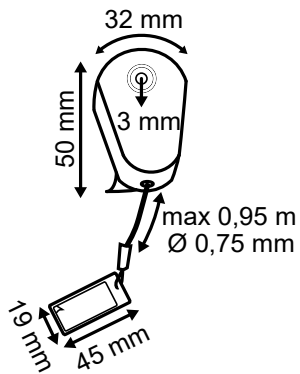

8.2 Handles

A variety of injection molded handles can be inserted into special cardboard boxes, for an easy transport of the given boxes.

HND4

Black or white carrying handle in soft PE.
→ Different colors supplied on request.

HND6

Black or white carrying handle in soft PE.
→ Different colors supplied on request.

HND30

Black or white carrying handle in PP with reinforcement plate.
→ Only supplied on request.

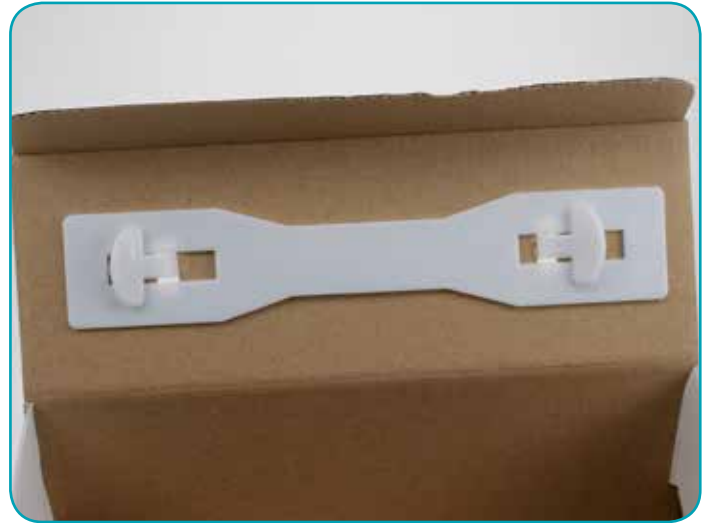

	L	W	COLOR	<input checked="" type="checkbox"/>	
HND4	163 mm	24 mm	White/Black	•	
HND6	155 mm	25 mm	White/Black	•	
HND30	187 / 156 mm	25 / 35 mm	White/Black		•

HND4

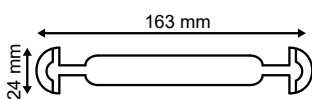

HND6

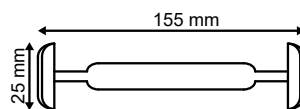
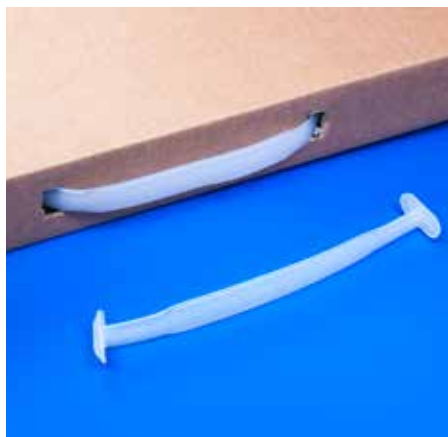

HND30

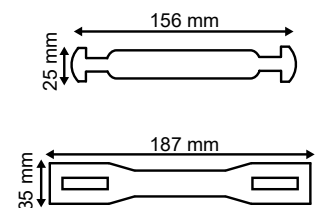

8.3 Calendar accessories

Our standard programme includes different window sizes. Our standard color is red and other colours are available on request. Date indicators which consist of several parts (window, carrier band and holder) can be assembled prior to delivery.

DAT5

Clear PVC date indicator with perforations and elastic (T-end). Self-assembly.
 → Can be used for a calendar width from 28cm to 38cm.

	WINDOW SIZE	OUTER SIZE	<input checked="" type="checkbox"/>	
DAT5/1515	15 x 15mm	23 x 30mm	●	
DAT5/1525	15 x 25mm	23 x 41mm	●	
DAT5/1729	17 x 29mm	26 x 44mm	●	
DAT5/1738	17 x 38mm	26 x 53mm	●	
DAT5/1929	19 x 29mm	28 x 46mm	●	
DAT5/2334	23 x 34mm	32 x 49mm	●	
DAT5/2840	28 x 40mm	38 x 56mm	●	



DATE INDICATORS SUPPLIED ON REQUEST

Clear PVC date indicator with elastic.

	SYSTEM	Calendar Width	WINDOW	<input checked="" type="checkbox"/>	
DAT1	Block System	170mm to 500mm	Custom made		●
DAT2	Block System	95mm	Window 22 & 23		●
DAT3	Page System	95mm	Window 22 & 23		●

DAT1



DAT2



DAT3



Formats date indicators

L x H

1. INSIDE: 12 x 10 mm
OUTSIDE: 18 x 16 mm

2. INSIDE: 15 x 14 mm
OUTSIDE: 23 x 20 mm

3. INSIDE: 18 x 16 mm
OUTSIDE: 26 x 24 mm

4. INSIDE: 30 x 23 mm
OUTSIDE: 38 x 33 mm

5. INSIDE: 35 x 30 mm
OUTSIDE: 45 x 40 mm

6. INSIDE: 20 x 14 mm
OUTSIDE: 26 x 20 mm

7. INSIDE: 30 x 20 mm
OUTSIDE: 38 x 30 mm

8. INSIDE: 26 x 19 mm
OUTSIDE: 35 x 28 mm

9. INSIDE: 42 x 27 mm
OUTSIDE: 50 x 38 mm

10. INSIDE: 38 x 17 mm
OUTSIDE: 46 x 24 mm

11. INSIDE: 26 x 14 mm
OUTSIDE: 34 x 22 mm

12. INSIDE: 25 x 12 mm
OUTSIDE: 31 x 18 mm

13. INSIDE: 45 x 22 mm
OUTSIDE: 55 x 32 mm

14. INSIDE: 25 x 16 mm
OUTSIDE: 33 x 26 mm

15. INSIDE: 20 x 30 mm
OUTSIDE: 30 x 40 mm

16. INSIDE: 35 x 22 mm
OUTSIDE: 43 x 30 mm

17. INSIDE: 27 x 16 mm
OUTSIDE: 35 x 24 mm

18. INSIDE: 15 x 12 mm
OUTSIDE: 20 x 16 mm

19. INSIDE: 33 x 22 mm
OUTSIDE: 41 x 30 mm

20. INSIDE: 28 x 21 mm
OUTSIDE: 35 x 28 mm

21. INSIDE: 8 x 13 mm
OUTSIDE: 15 x 20 mm

22. INSIDE: 10 x 8 mm
OUTSIDE: 14 x 12 mm

23. INSIDE: 13 x 8 mm
OUTSIDE: 18 x 12 mm

24. INSIDE: 19 x 22 mm
OUTSIDE: 27 x 29 mm

25. INSIDE: 30 x 14 mm
OUTSIDE: 38 x 17 mm

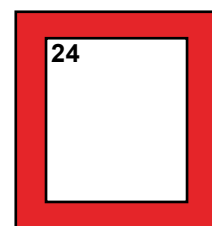
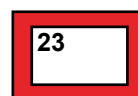
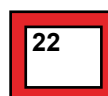
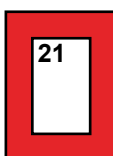
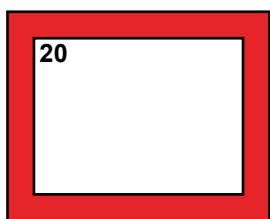
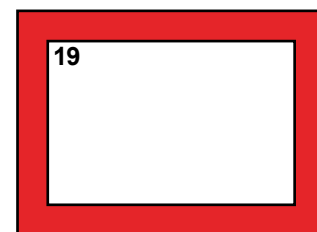
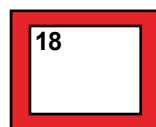
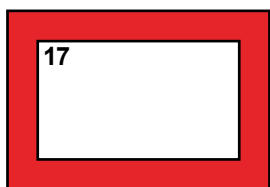
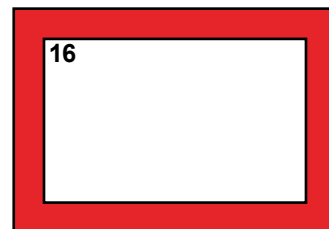
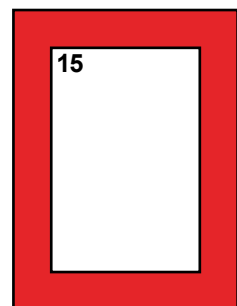
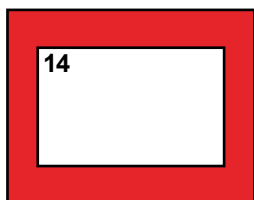
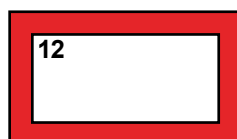
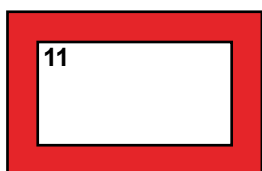
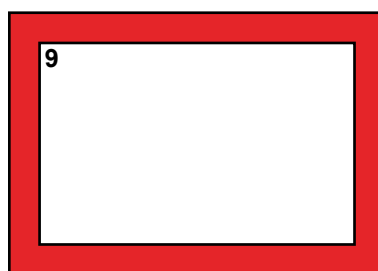
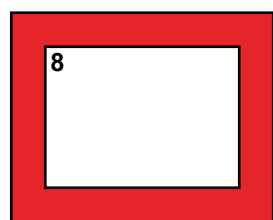
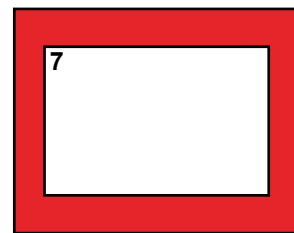
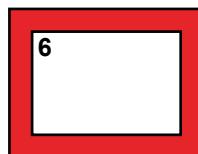
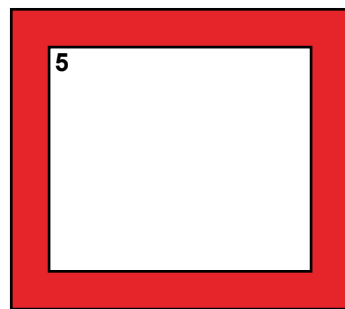
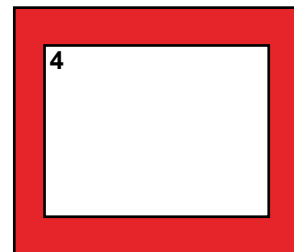
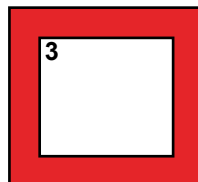
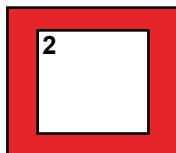
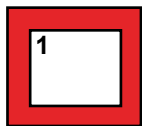

TERMS & CONDITIONS OF SALE

1 - GENERAL

- 1.1 In these conditions 'The Company' refers to All-Round NV and the 'Customer' refers to the purchaser of the goods.
- 1.2 The Customer agrees that the conditions set out below shall be incorporated into any contract with the Company.
- 1.3 Clerical errors may be corrected by the Company at any time

2 - FORMATION OF CONTRACT

- 2.1 The Customer's standard terms or any other terms provided by the Customer shall not be incorporated into the contract or any variation thereof less expressly accepted by the Company in writing.
- 2.2 The order consists of an acceptance by The Company to supply the goods and or services upon The Company's terms and conditions here set out and shall, unless previously cancelled by The Company by written notice to The Customer, be deemed to be accepted upon receipt by The Company of The Customers' written or verbal instructions to supply goods and or services, by accepting delivery of any part of the Goods and or services. The Terms and Conditions here set out shall apply to the contract to the exclusion of all Customer order terms and conditions on which any purchase order has been given to The Company or subject to when the order is accepted or purported to be accepted by The Company. Neither party shall be bound by any variation, waiver or addition or exclusion to the terms and conditions here set out unless agreed in writing between the authorised representative of The Company and The Customer.

3 - QUOTATIONS

- 3.1 All prices are, unless otherwise stated, quoted Ex Works exclusive of delivery costs and VAT. The Company reserves the right to be exercised at it's discretion, to vary the price of goods, if, subsequent to the date of the quotation there is any increase or decrease in the total cost to the Company of producing or acquiring the goods which is beyond the Company's control.
- 3.2 In such an event the Company will give written notice to the Customer before delivery. If such alteration increases the price, the Customer may cancel the relevant order by notice given to the Company within 3 days of the date of the notification of the increase by the Company.

4 - SAMPLES

The Company may at its discretion submit a sample to the Customer for approval before executing the bulk of the order, which will only be commenced on receipt of such approval in writing. All goods in respect of which is sampled is so approved shall be deemed to have been satisfactorily tested by the Customer and to comply with the specification for the goods.

5 - WARRANTIES

- 5.1 The goods shall be of satisfactory quality and will conform to any specification agreed by the Company in writing, within the normal limits of industrial quality for such goods.
- 5.2 The liability of the Company for breach of the above term, or any claim in respect of any defect in the goods, shall be limited to replacement of the defective goods or, at the Company's option, reimbursement of the price paid for those goods. The company's responsibility is strictly limited to the pure and simple replacement of any defective recognized goods /parts by cross-examination after return in our stores, whatever the nature of the defect is. This excludes any damages & failures whatever they are.
- 5.3 The Customer shall not be entitled to make any claim in respect of any such defective goods unless the claim is notified to the Company in writing within 7 days from delivery of the goods.
- 5.4 The Company shall not be liable to the customer where the defect or damage in respect of which a claim is made has been caused or contributed to by:
 - 5.4.1 Abnormal usage of the goods. The company cannot accept complaints for goods which were used or transformed by the buyer.
 - 5.4.2 An act or omission of anyone other than The Company.
- 5.5 Any particular purpose for which the goods are to be fit must be agreed in writing between the Company and the Customer. If no such agreement is made, the customer acknowledges and agrees that he has not made known expressly or by implication to the Company any particular purpose for which the goods are being bought.
- 5.6 Save as set out above:
 - 5.6.1 All terms relating to the quality of the goods or to the fitness to the goods for a particular purpose are excluded from any contract between the Company and the Customer.
 - 5.6.2 The Company shall be under no liability in respect of any defect in the goods.

6 - DELIVERY

- 6.1 Time is not of the essence of the contract.
- 6.2 If the Company does not deliver the goods within 21 working days of the date stated for delivery on the order then the Customer may give written notice to the Company that delivery is required within a period of not less than 14 days, to be sent by recorded delivery. If the Company fails, without good reason, to commence delivery of the goods within the stated period then the Customer may cancel the order. In the event of such cancellation the Customer shall not be liable to pay any further sums in respect of goods which have not been delivered.
- 6.3 The Customer shall have no right to damages for any failure on the Company's part to deliver the goods in accordance with the time stated for delivery.
- 6.4 Where an order requires delivery of a number of items, the Company reserves the right to deliver all or any number of those items as soon as they are available and the Customer shall honour all statements presented in respect of such deliveries in accordance with the payment terms.

7 - INSPECTION AND ACCEPTANCE

- 7.1 If the Customer wishes to inspect the goods prior to delivery, such inspection must be made at the Company's premises and notification of this requirement must be given in writing at the time of placing the order. If upon inspection goods are approved by or on behalf of the Customer then such approval shall constitute acceptance by the customer that the goods conform with their specification and that the goods are fit for any particular purpose agreed under clause 4.
- 7.2 If no such inspection is made then, unless the Customer gives written notification to the contrary to the Company within 3 working days after delivery, the Customer shall be taken to have approved the goods and to accept that the goods conform with their specification and that the goods are fit for any particular purpose agreed under clause 4.

8 - SPECIFICATION

- 8.1 All drawings, descriptions, specifications and particulars of the goods to be supplied are approximate only.
- 8.2 The descriptions and illustrations contained in the catalogues, on the website and other advertising of the Company have been provided in good faith by the Company but:
 - 8.2.1 No such description, illustration, price list or other advertising shall form part of the contract;
 - 8.2.2 If the Customer wishes to rely on any such description, illustration, price list or other advertising in entering into the contract it must notify the Company in writing before the Company provides a quotation. If no such notification is given, the Customer agrees that it did not rely on any such representation in entering into the contract.
- 8.3 The Company reserves the right to incorporate new features and to supply products which may not be strictly in accordance with the specification agreed upon, provided that any changes in specification shall not materially prejudice the performance of the goods.

9 - QUANTITIES

- 9.1 The quantity of the goods ordered shall be subject to a tolerance of +/- 10 %. Any quantity delivered within the accepted tolerance will be invoiced at the agreed rate.
- 9.2 The Company cannot accept complaints for waste or damage lower than 5 % of the order.
- 9.3 A receipt in respect of the delivery must be signed on receipt of the goods by the Customer or his representative at the Customers premises. Unless the Customer notifies the Company in writing of any shortfall within 48 hours of delivery, the Customer is taken to accept that the correct quantity has been delivered. The Company will have no liability for any shortfall and will be entitled to payment for the full quantity.

10 - PAYMENT

- 10.1 Payment for the goods must be made within 30 days of the date of the invoice.
- 10.2 In the event of non-payment within 30 days, then the Company may charge interest on all unpaid sums at a rate of 8% over the current base rate prevailing in Belgium.
- 10.3 The Company does implement it's statutory right to interest.

11 - EURO PROTECTION

Where it is agreed that payment for the goods is to be made in any currency other than € Euro the Company reserves the right to be exercised at its discretion to vary the price so as to take into account any changes in the rate of exchange between the date of the Company's quotation and the date of the invoice.

12 - RETURNS

Goods can only be returned if written authorisation has been received from the Company. The goods must be in their original cartons. Incomplete cartons will not be accepted.

13 - RISK

Risk in the goods shall pass to the Customer on delivery.14 - TITLE

14.1 Until full payment for all goods has been received by the Company:

14.1.1 Property in all goods shall remain in the Company, notwithstanding delivery of the goods or any part of them;

14.1.2 The Customer shall be at liberty to sell or deal with the goods in the ordinary course of business, but until full payment in respect of all goods has been made;

a) The Customer shall hold the Goods as trustee of the goods for the Company:

b) The Customer shall hold any rights to payment or other consideration arising out of any sale of the goods in trust for the Company and agrees to assign such rights to the company upon request by the Company;

c) The Customer shall hold the proceeds of any sale of the goods as trustee for the Company. The proceeds shall not be mingled with other monies or paid into any overdrawn bank account and such monies shall at all times be identifiable as the Company's monies. The Customer as trustee for the Company shall not be entitled to deal with such monies in any manner whatsoever.

14.2 The Customers power to sell or deal with the goods in the ordinary course of business shall be automatically revoked if the Company cancels the order under clause 15 below.

14.3 Upon determination of the Customers power of sale, the Company shall be entitled to reclaim the goods and the customer grants the company a license to enter the Customers premises for that purpose.

15 - CANCELLATION

15.1 If at any time the Customer cancels an order for goods or services which do not appear in the Company's most recent catalogue or which are, in the Company's opinion non standard, then the Company shall be entitled to claim an amount up to 85% of the value of the order, as liquidated damages for stock. The Customer agrees that the said amount represents a genuine pre-estimate of the Company's loss. The said sum shall be recoverable by the Company from the Customer as a debt.

15.2 If the Customer fails to make the correct payment to the Company for the products by the date on which any such payment is due, or makes a composition or arrangement with his creditors, or becomes bankrupt or being a company makes a proposal for a voluntary arrangement for a composition of debts or scheme of arrangements to be approved in accordance with the Companies Act 1985 or the Insolvency Act 1986 as the case may be or any amendment or re-enactment thereof, or has a provisional liquidator appointed or has a winding up order made or passes a resolution for voluntary winding up or under the insolvency Act 1986 or any amendment or re-enactment thereof has an administrator or an administrative receiver appointed then:

15.2.1 The Customer shall immediately inform the Company;

15.2.2 The Company may by notice in writing to the Customer cancel the order any other orders which may be outstanding between the Customer and the Company.

15.3 In the event of such cancellation:

15.3.1 The Company shall be entitled to reclaim the goods in accordance with the provisions of clause 14 above;

15.3.2 The Customer shall remain liable to pay the Company the full purchase price for the goods less (i) the disposal value received by the Company for the whole or part of the goods in its possession or reclaimed by the Company under paragraph 14 above (ii) any part of purchase price for the goods paid by the Customer to the Company and (iii) any direct costs incurred by the Company in the direct costs incurred by the Company in the performance of the order. The Company's determination of such amount shall, in the absence of manifest error, be binding on the Customer.

16 - FORCE MAJEURE

The company shall not be liable to the Customer for failure to deliver the goods or for any delay in delivery of the goods or for any damage to or defect in the goods where such failure is caused or contributed to by any cause outside the Company's reasonable control, including but not limited to shortages of raw materials, strikes, riots and civil commission or acts of God, theft, water and embargo.

17 - LAW AND JURISDICTION

These conditions are governed by Belgian Law. Any disputes shall be submitted to the exclusive jurisdiction of the Belgian courts (Ghent).



**Looking for a unique range or bespoke product,
do not hesitate to contact our experienced and
professional customer service team.**

BUSINESS HOURS :

MONDAY TO THURSDAY : 8.30 am → 12.30 pm - 01.00 pm → 05.00 pm

FRIDAY: 8.30 am → 12.30 pm - 01.00 pm → 04.00 pm

**(+32 (0)9 363 93 60
Mail: export@all-round.be**

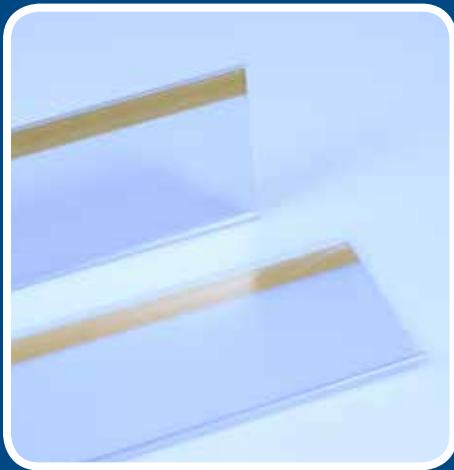

All Round[®] NV

export@all-round.be
www.all-round.be

Industrielaan 27 bus 2 | 9320 Erembodegem Belgium | ☎ +32 (0)9 363 93 60